

Lecture 13 - Wastewater Screening, Primary Treatment

General layout for wastewater treatment plant:

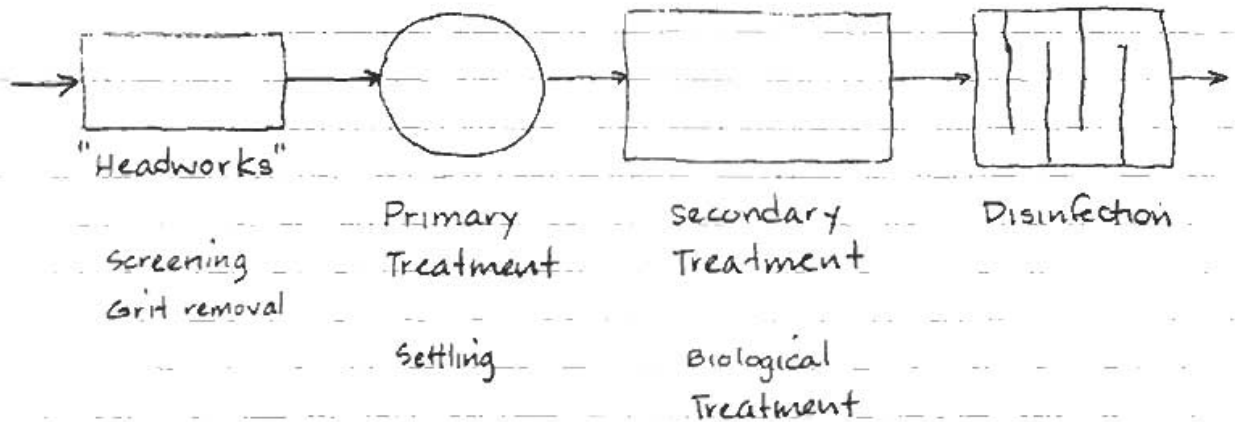

Screening

Removes large material to:

1. Protect process equipment
2. Prevent interference with treatment
3. Prevent discharge to waterways

Types of screens: (Figure 5-2 from M&E - page 2)

Coarse screens ("bar rack" - Figure B.1 from Mara - pg 3)

May be hand raked for small systems

Most are mechanically cleaned

often subject to mechanical problems

Design requires minimum velocity - 0.4 m/s - to keep grit suspended - maintained by downstream weir or flume

Screenings are disposed by landfilling or incineration, sometimes passed through grinder and into waste stream (grinder also called comminutor
com-in-it-NEW-ter)

Coarse screens usually have ~5 cm openings

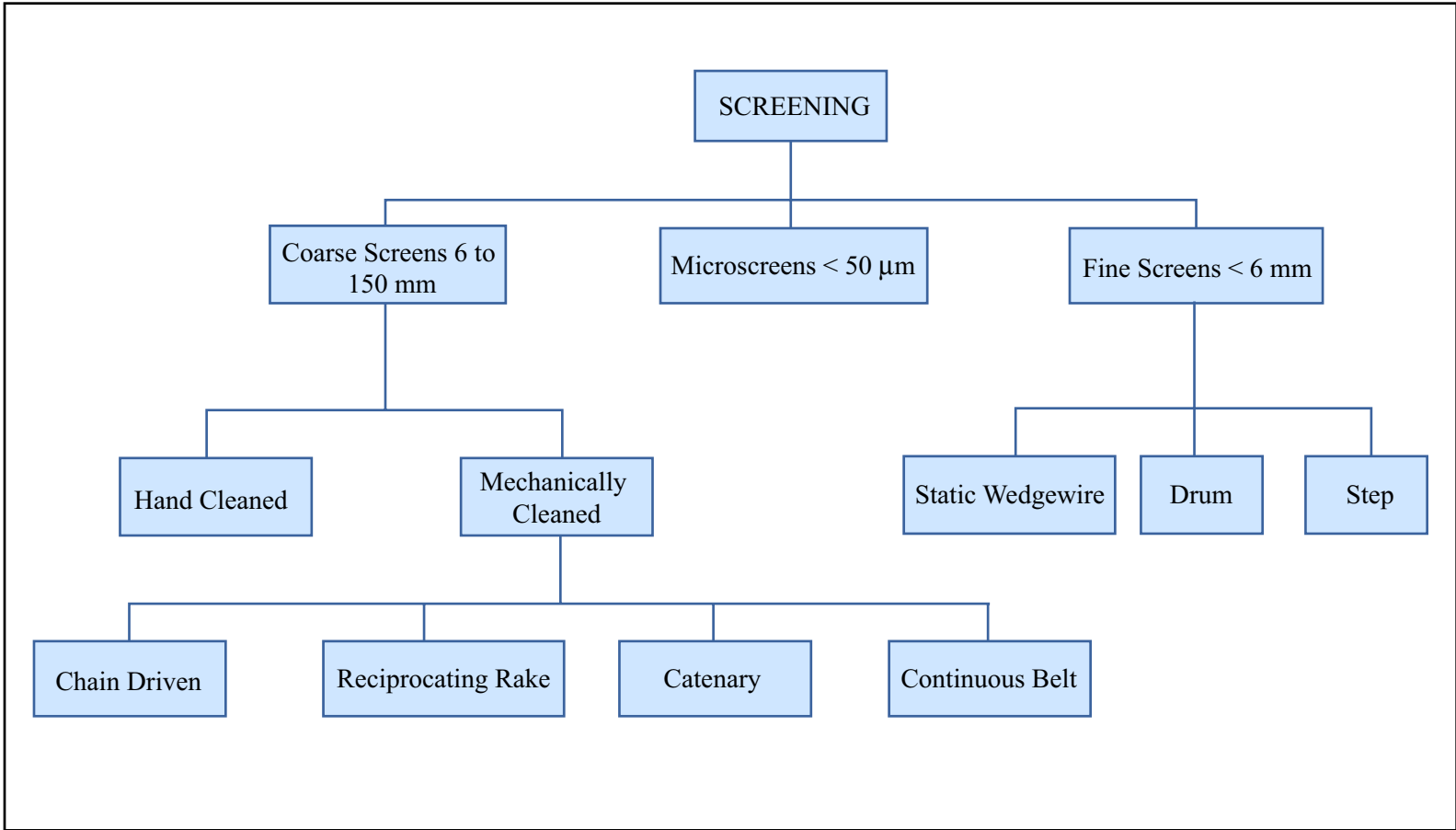
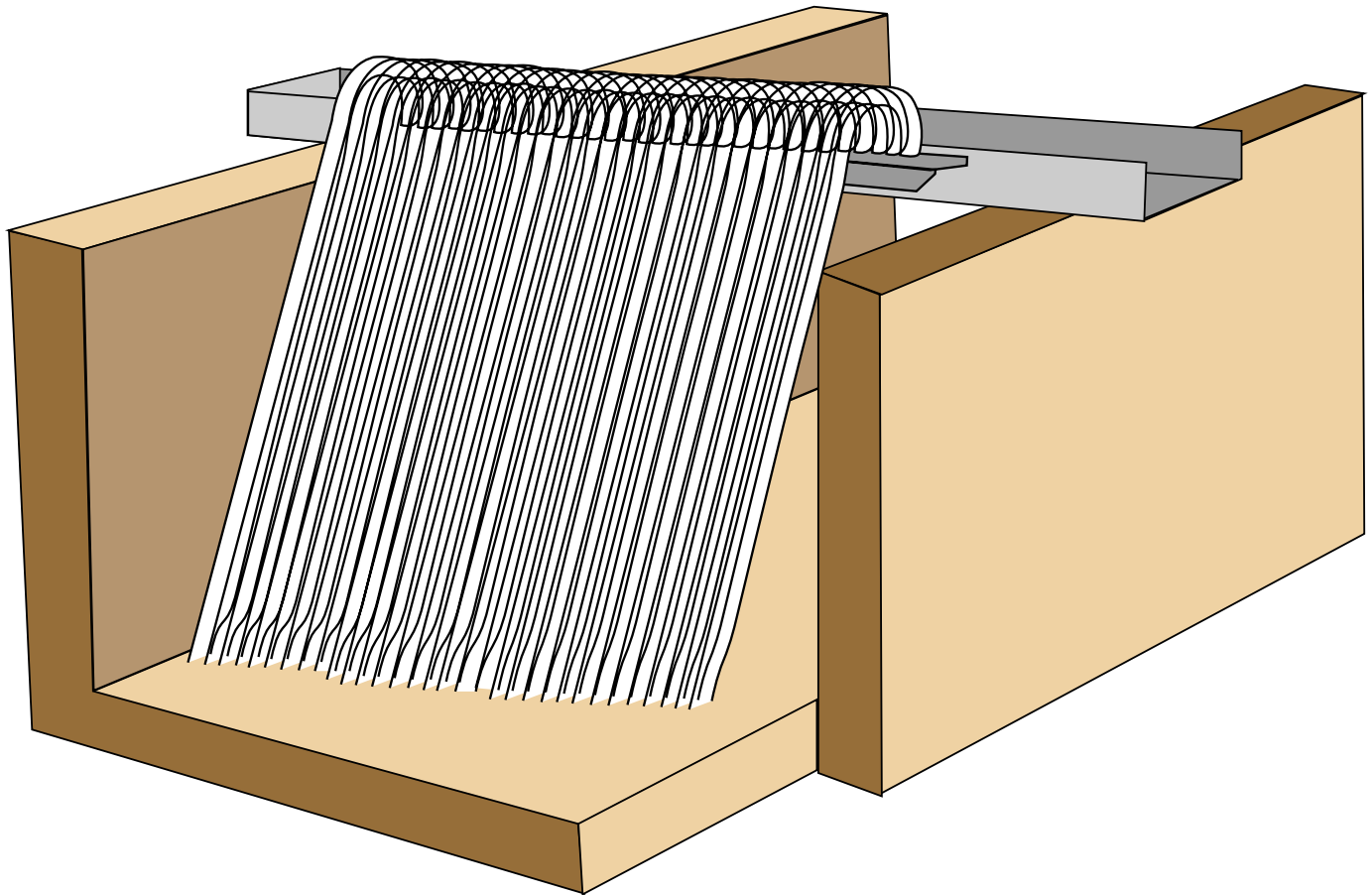

Figure by MIT OCW. Adapted from Metcalf & Eddy Inc., G. Tchobanoglous, F. L. Burton, and H. D. Stensel, 2003. Wastewater Engineering: Treatment and Reuse, Fourth Edition. McGraw-Hill, New York.



Simple Manually Raked Screen (flow is from left to right)

Figure by MIT OCW.

Adapted from: Mara, D. *Domestic Wastewater Treatment in Developing Countries*. London, UK: Earthscan, 2005, p. 79.

Coarse screens are sometimes followed by fine screens
(≤ 6 mm opening - usually 6 mm) -

Fine screens are expensive, high in maintenance
Not used commonly for municipal wastewater

Fine screens can remove 10-80% TSS
average removal = 55%

Grit chambers

Designed to remove sand, gravel, cinders, coffee grounds,
egg shells, other high-density organics and inorganics

Purposes:

1. Protect moving equipment from abrasion
2. Reduce deposition in pipelines, channels
3. Reduce frequency of digester cleaning

Grit characteristics:

$0.004 - 0.04 \text{ m}^3 \text{ grit} / \text{m}^3 \text{ wastewater}$ (higher with
combined sewers)

Solids content = 35-80%

Volatile content = 1-55%

Typical density $\approx 1.6 \text{ gm/cm}^3$

Grit chamber design

Design goal:

- Provide sufficient detention time for grit to settle
- Maintain constant velocity to scour organics

Velocity needed to scour organics given by Camp-Shields equation (Camp, 1942, Grit Chamber Design, Sewage Works Journal, Vol 14, pp 368-381)

$$V_c = \sqrt{\frac{8 K g d}{f} \left(\frac{\rho_p - \rho_w}{\rho_w} \right)}$$

V_c = scour velocity [L/T]

g = gravitational acceleration [L/T²]

d = particle diameter [L]

f = Darcy-Weisbach friction factor [-]

= 0.002 for domestic sewage

ρ_p = particle density [M/L³]

ρ_w = water density [M/L³]

K = empirical constant related to "stickiness" of organic particles = 0.04 - 0.06

Typically V_c = 15 to 30 cm/s for organic particles

Challenge in grit chamber design is to maintain V_c through fluctuations in flow rate

One alternative - design outflow weir to maintain velocity in rectangular channel

$$V_c = \frac{Q}{wh} = \text{constant}$$

w = channel width = constant for rect channel

h = elevation above weir crest

$$\rightarrow w V_c = \frac{Q}{h} = \text{constant}$$

$$\text{Flow over a weir} = Q = C_w \sqrt{2g} h^{3/2} W$$

L = length of weir \perp to flow

C_w = weir coefficient, which varies with characteristics of weir

$C_w \approx 0.4$ for sharp-crested weir

Refresher on weirs:

Weir = obstruction in channel over which fluid must flow

Example:
Sharp-crested weir

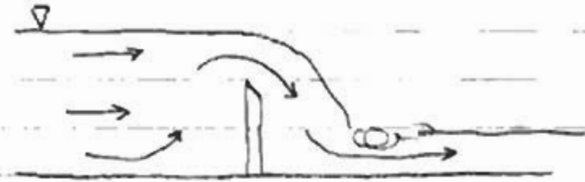

Bernoulli eqn. for approach to weir:

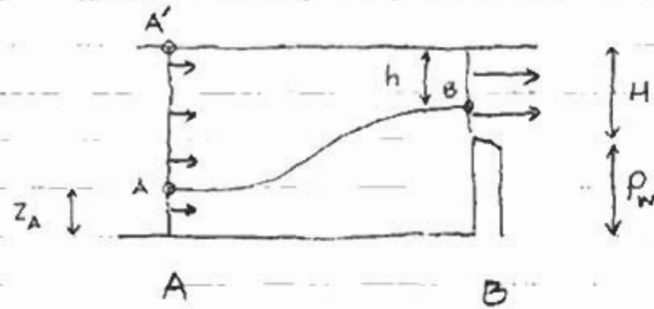

$$\frac{P_A}{\rho g} + \frac{V_A^2}{2g} + z_A = \frac{P_B}{\rho g} + \frac{V_B^2}{2g} + (H + P_w - h) \quad (1)$$

0
since at
atmospheric P

Total head at surface at section A is everywhere the same. Therefore, assuming uniform V :

$$\frac{P_A}{\rho g} + \frac{V_A^2}{2g} + z_A = \frac{P_{A'}}{\rho g} + \frac{V_{A'}^2}{2g} + z_{A'} = \frac{V_A^2}{2g} + H + P_w \quad (2)$$

Replace L.H.S. of Eq. 1 with R.H.S. of Eq. 2

$$\frac{V_A^2}{2g} + H + P_w = \frac{V_B^2}{2g} + H + P_w - h \quad (3)$$

$$\text{or } \frac{V_B^2}{2g} = \frac{V_A^2}{2g} - h \quad (4)$$

$$V_B = \sqrt{2g \left(h + \frac{V_A^2}{2g} \right)} \quad (5)$$

For weir with uniform width L

$$Q = L \int_{h=0}^{h=H} V_B dh \quad (6)$$

$$= L \int_{h=0}^{h=H} \sqrt{2g \left(h + \frac{V_A^2}{2g} \right)} dh \quad (7)$$

$$= \frac{2}{3} \sqrt{2g} L \left[\left(H + \frac{V_A^2}{2g} \right)^{3/2} - \left(\frac{V_A^2}{2g} \right)^{3/2} \right] \quad (8)$$

$$\text{If } \frac{V_A^2}{2g} \ll H:$$

$$Q = \frac{2}{3} \sqrt{2g} L H^{3/2} \quad (9)$$

To correct for approximations in getting to Eq 9,
add weir coefficient -

$$\begin{aligned} Q &= C_{wr} \frac{2}{3} \sqrt{2g} L H^{3/2} \\ &= C_w \sqrt{2g} L H^{3/2} \end{aligned} \quad (10)$$

Constant flow velocity is achieved by proportional or Sutro weir

Opening has
this shape =

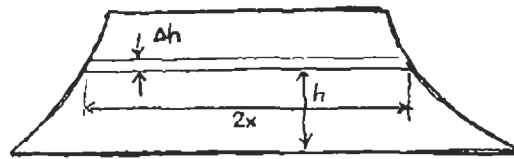

Consider flow in height increment Δh :

$$\begin{aligned}\Delta Q &= V \Delta h 2x \\ &= \sqrt{2g(h + v^2/2g)} \Delta h 2x && \text{From pg 7, eq 5} \\ &\approx C_w \sqrt{2gh} \Delta h \cdot 2x && \text{From pg 7, eq 10}\end{aligned}$$

Total flow is

$$Q = \int_0^h C_w \sqrt{2gh} 2x dh$$

$$\text{where } 2x = \text{function of } h = \frac{k}{\sqrt{h}}$$

$$Q = \int_0^h C_w \sqrt{2gh} \frac{k}{\sqrt{h}} dh$$

$$= \sqrt{2g} C_w k \int_0^h dh = \sqrt{2g} C_w k h$$

$$\frac{Q}{h} = \sqrt{2g} C_w k = \text{const}$$

Thus, weir built to specification $2x = \frac{k}{\sqrt{h}}$ will produce constant velocity in upstream channel

Pg 9 (Reynolds & Richards, 1996, Fig 7.9) shows actual vs. theoretical proportional weir design

Pg 10 (Reynolds & Richards, 1996, Fig 7.7) shows grit chamber design with proportional weir

Weir coefficient for proportional weir $C_w \approx 0.98$

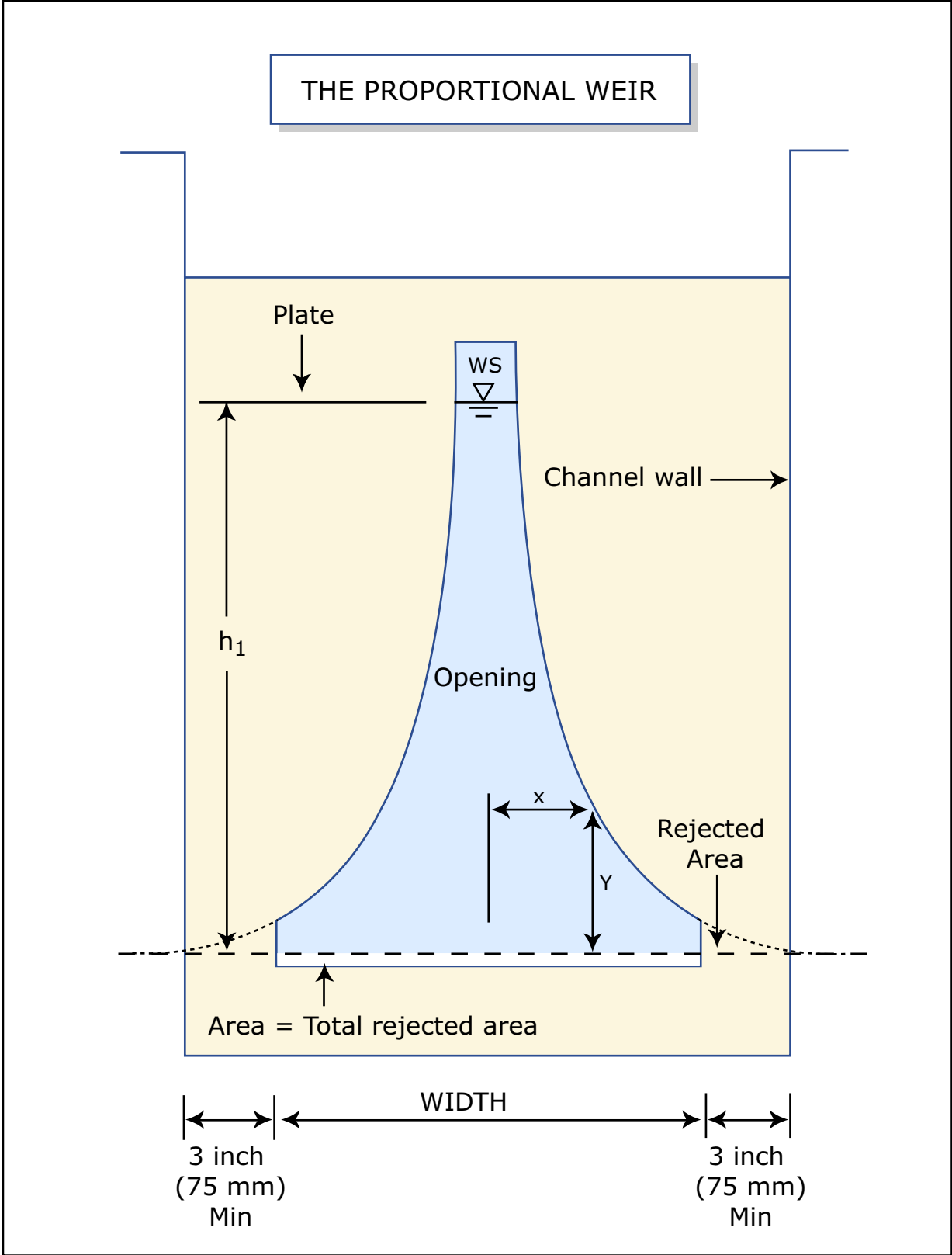
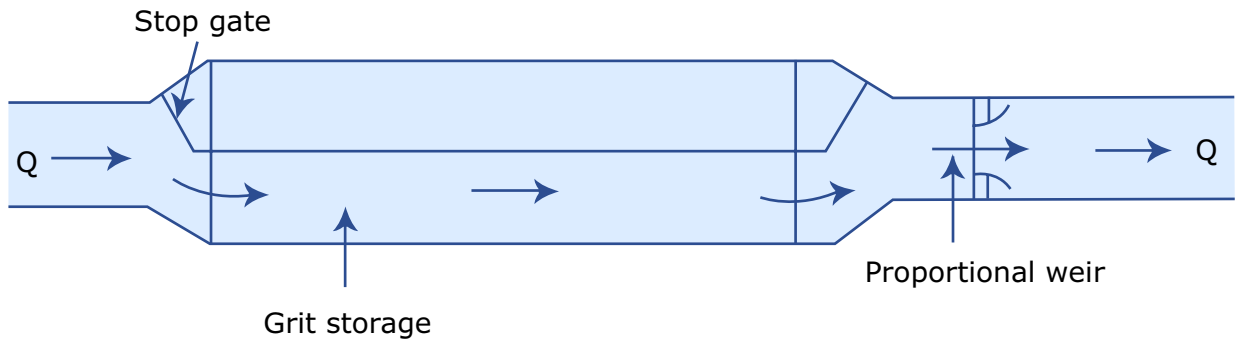

Figure by MIT OCW.

Adapted from: Reynolds, T. D., and P. A. Richards. *Unit Operations and Processes in Environmental Engineering*. 2nd ed. Boston, MA: PWS Publishing Company, 1996, p. 142.

A Horizontal-Velocity Grit Settling Chamber with a Proportional Weir Control Section



(A) PLAN

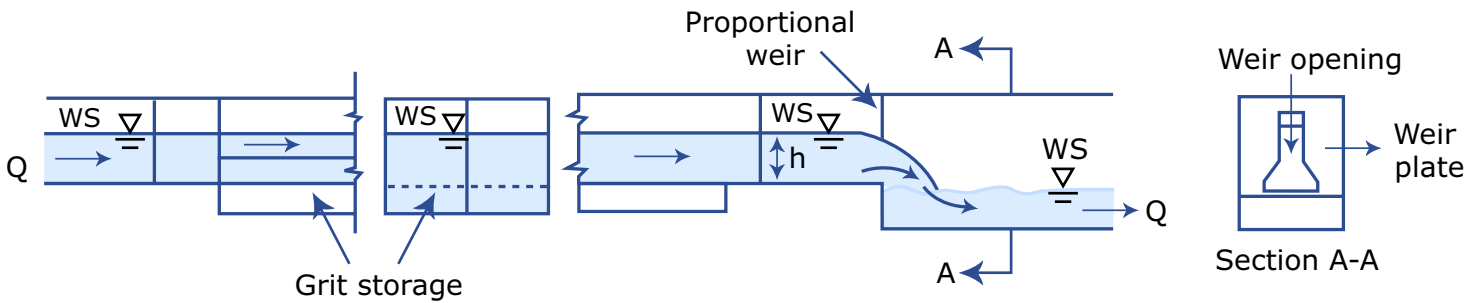

(B) PROFILE & CHANNEL CROSS SECTION

Figure by MIT OCW.

Adapted from: Reynolds, T. D., and P. A. Richards. *Unit Operations and Processes in Environmental Engineering*. 2nd ed. Boston, MA: PWS Publishing Company, 1996, p. 141.

Alternative is to have outlet be a Parshall flume to measure flow into WWTP

Parshall flume has less head loss than proportional weir and is often preferred for that reason

Flume design eliminates sediment traps like that before a sharp-crested weir

Pg 12 shows Parshall flume (from Henderson, F. M., 1966. Open Channel Flow. MacMillan Publishing Co., NY)

Flow converges, creating critical flow, then diverges, going back to subcritical flow. Critical to subcritical flow creates standing wave.

$$Q = 4 W H_a^{1.522} W^{0.026}$$

For flume width $W = 1$ to 8 ft

This can be approximated as

$$Q = K W H_a^{3/2}$$

Configuration in wastewater plant is shown on page 13 (Figure 7.6 from Reynolds & Richards):

Grit removal chamber is followed by Parshall flume which creates head $H_a = h$ at grit chamber outflow.

As with proportional weir, goal is to design grit chamber to maintain constant velocity over range of Q

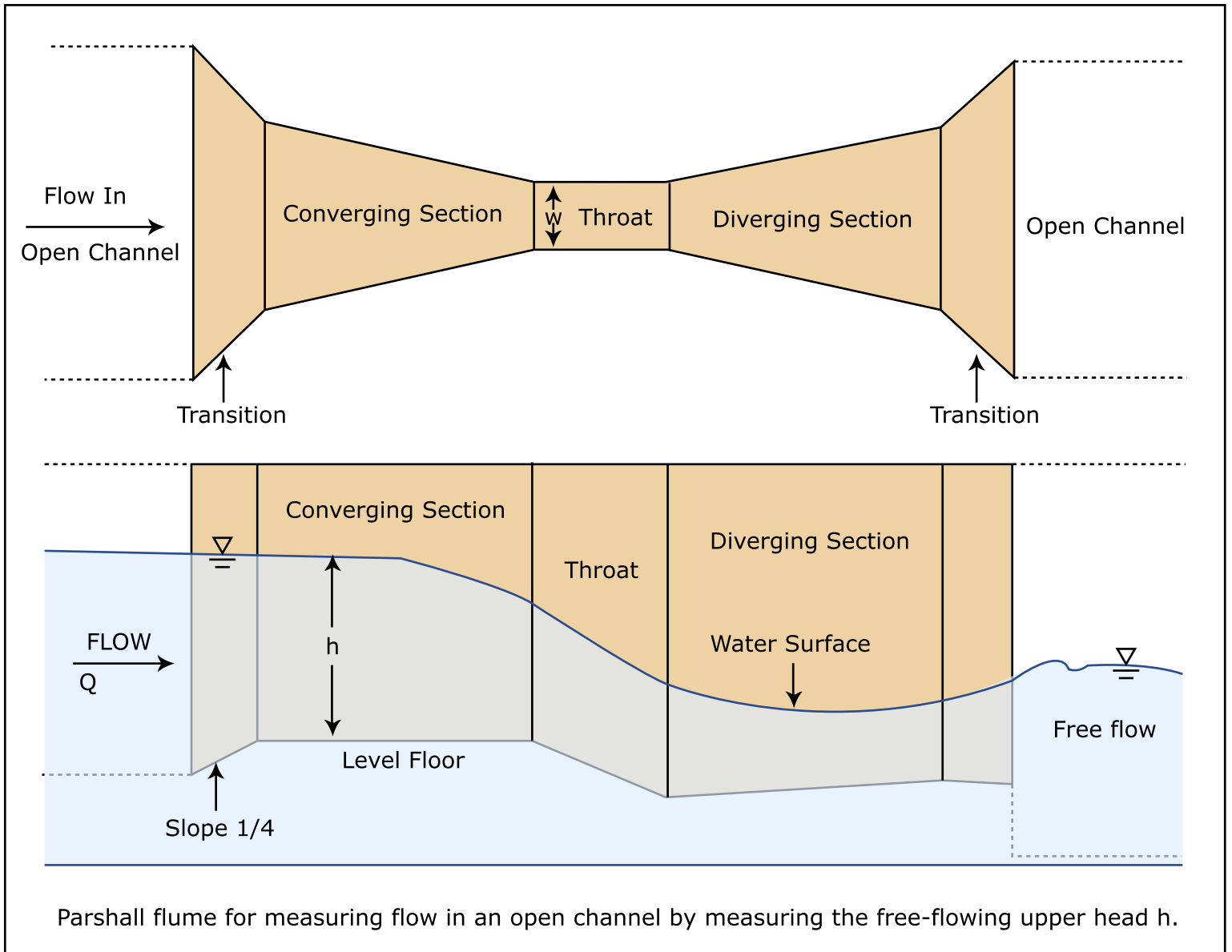

Figure by MIT OCW.

Adapted from: Viessman, W., Jr., and M. J. Hammer. *Water Supply and Pollution Control*. 7th ed. Upper Saddle River, NJ: Pearson Education, Inc., 2005, p. 353.

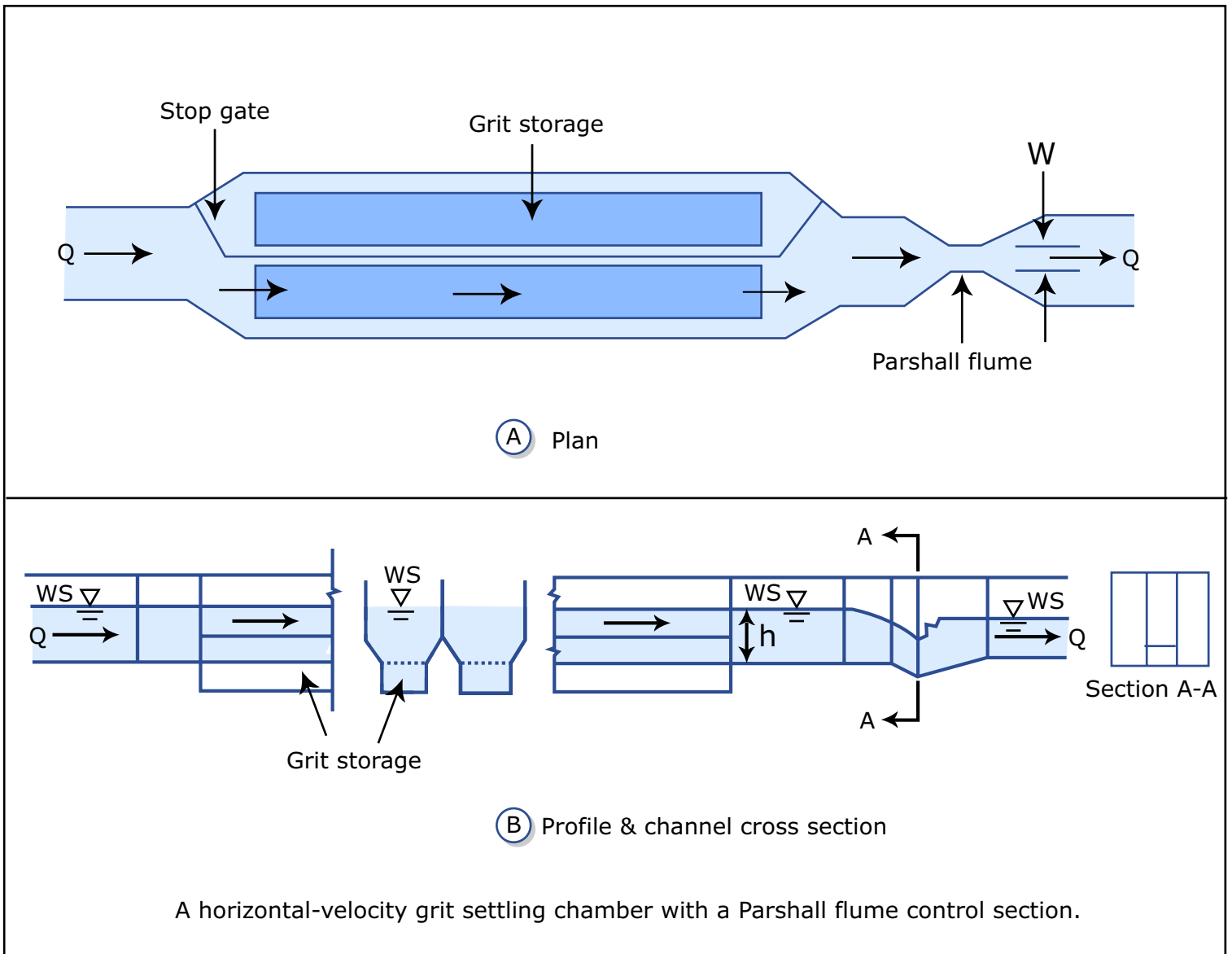

Figure by MIT OCW.

Adapted from: Reynolds, T. D., and P. A. Richards. *Unit Operations and Processes in Environmental Engineering*. 2nd ed. Boston, MA: PWS Publishing Company, 1996, p. 140.

Flow and head in flume are related as $Q = KW h^{3/2}$

Note h in flume establishes h in grit chamber

In grit chamber $v_c = \frac{Q}{A}$

Need to find chamber x-section shape such that $Q/A = \text{constant}$ for all Q

Differentiate weir equation to get incremental flow over depth interval dh :

$$dQ = \frac{3}{2} KW h^{1/2} dh \quad W \text{ is flume width}$$

Flow through channel x-section must be the same:

$$dQ = v_c x dh = \frac{3}{2} KW h^{1/2} dh$$

$x =$ width of x-section at height h

$$x = \left(\frac{3 KW}{2 v_c} \right) h^{1/2}$$

This defines parabolic x-section:

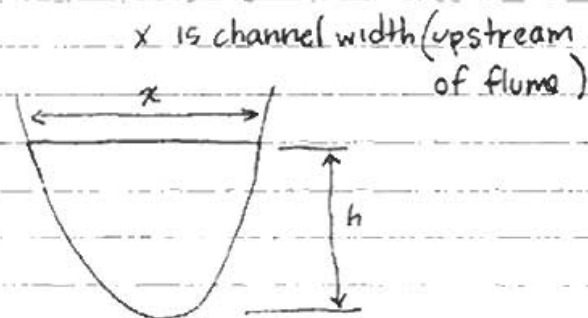

In practice, parabolic section is approximated by trapezoidal section for ease of construction - see Figure 7.10 of Reynolds & Richards - pg. 15

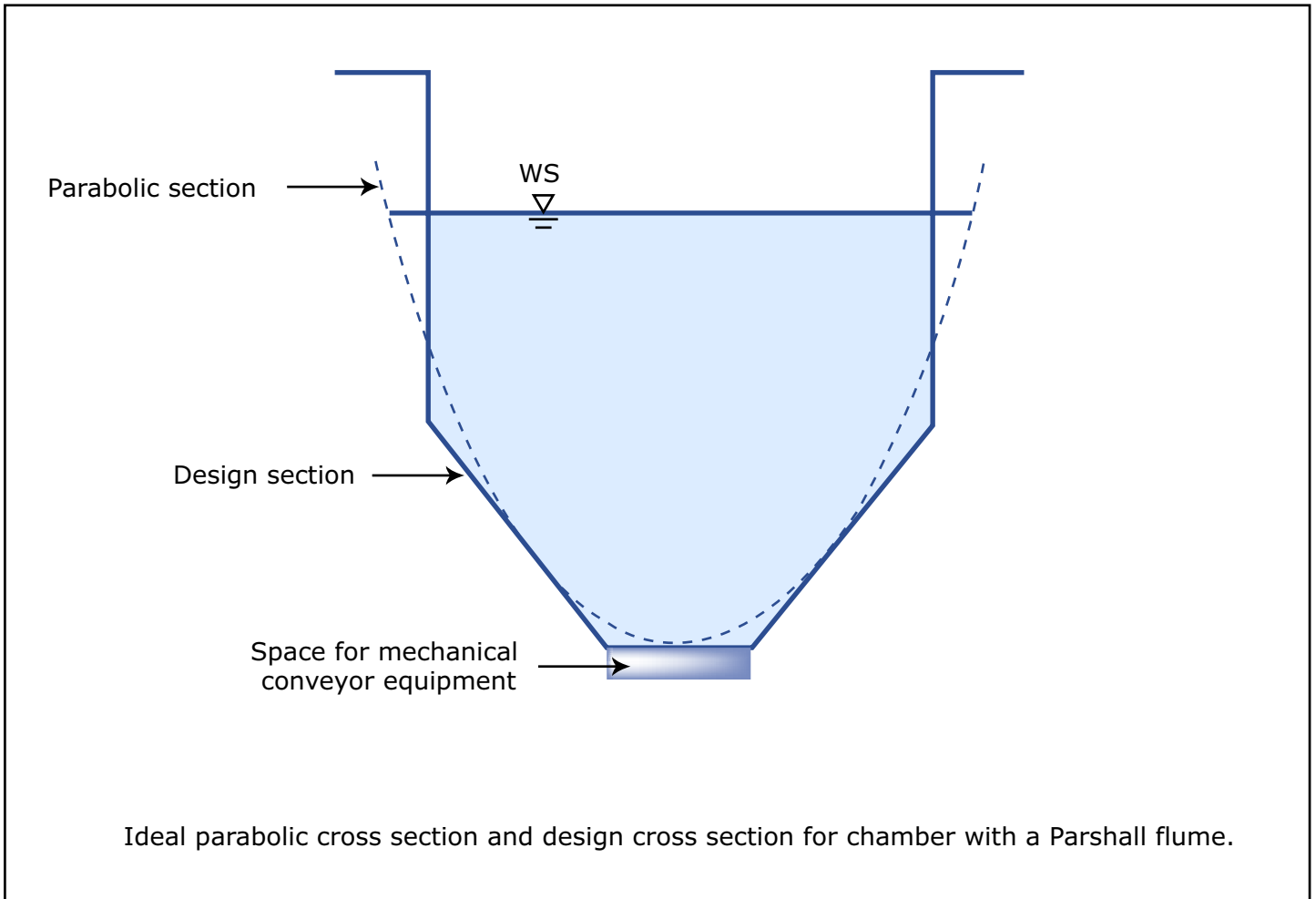

Figure by MIT OCW.

Adapted from: Reynolds, T. D., and P. A. Richards. *Unit Operations and Processes in Environmental Engineering*. 2nd ed. Boston, MA: PWS Publishing Company, 1996, p. 143.

Flow equalization

WWTP performance is improved if difference between nighttime low flow and morning high flow is reduced

This is achieved by in-line or off-line flow equalization (pg 17 - Figure 7.17 from R¹R)

Equalization basins store excess flow for later treatment

Design by examining cumulative flow over one day:

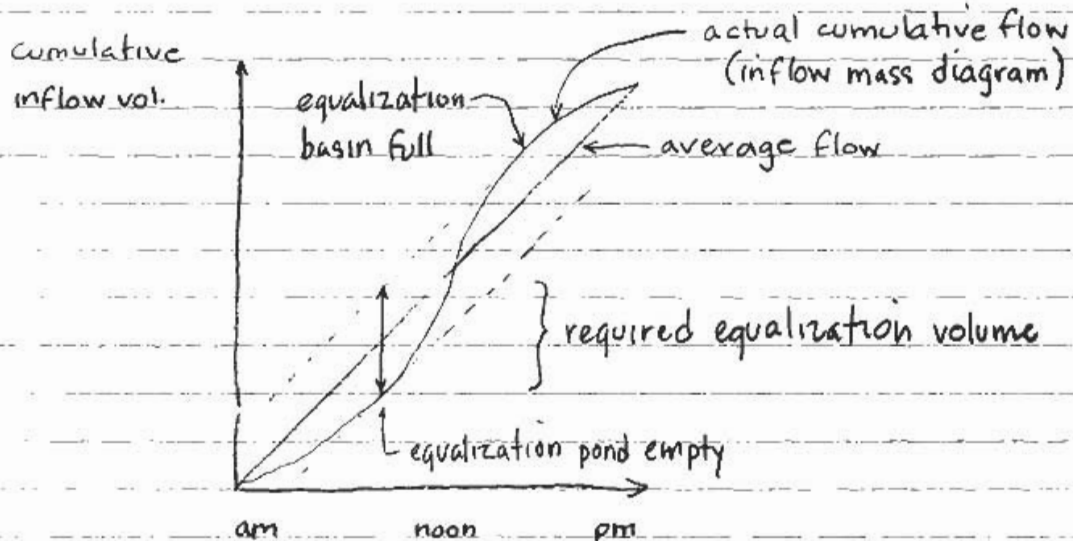

Alternatively, integrate part of Q vs t curve for $Q > Q_{ave}$ (pg 18, Figure 7.19 from R¹R)

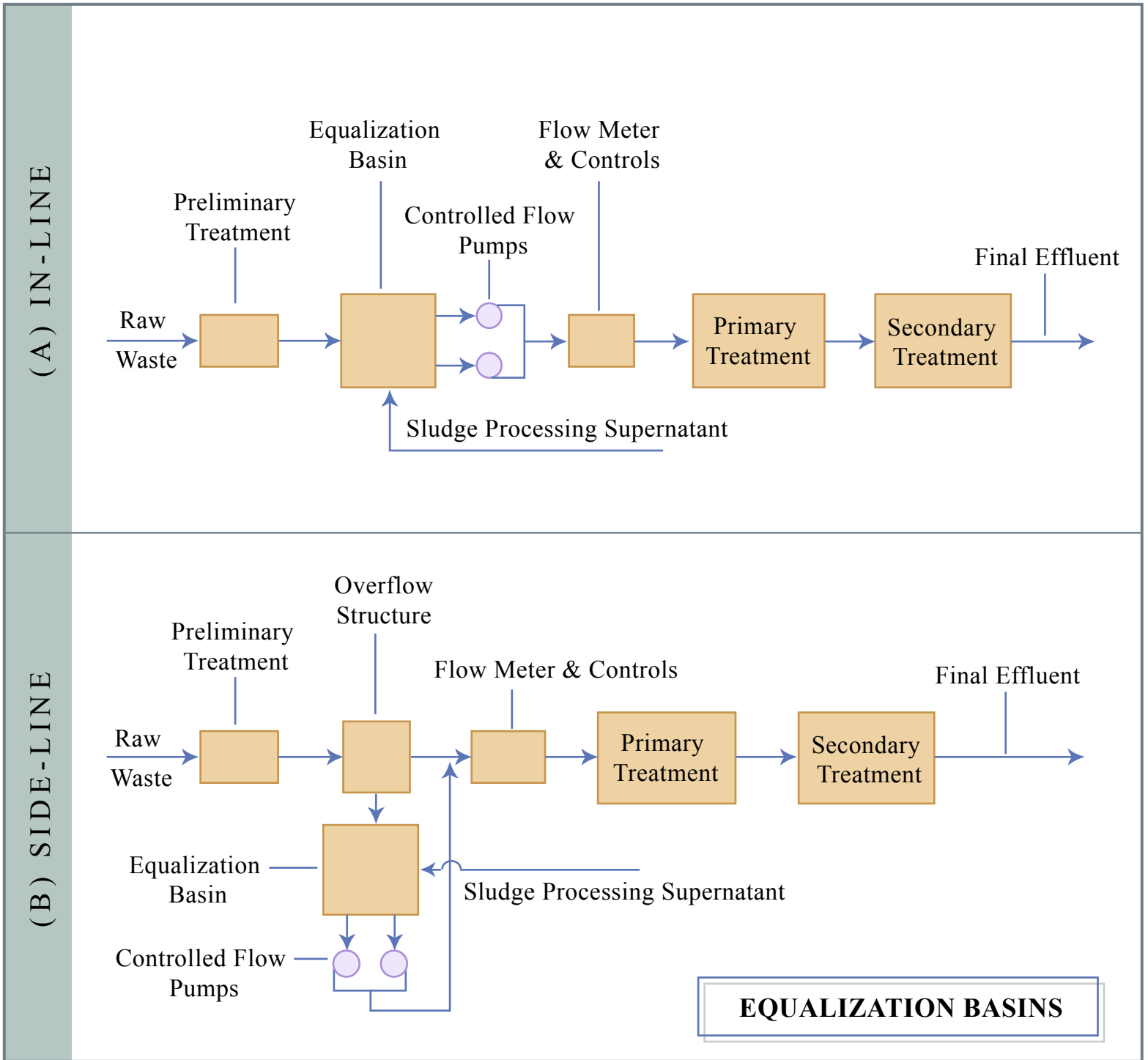

Figure by MIT OCW.

Adapted from: Reynolds, T. D., and P. A. Richards. *Unit Operations and Processes In Environmental Engineering*. 2nd ed. Boston, MA: PWS Publishing Company, 1996.

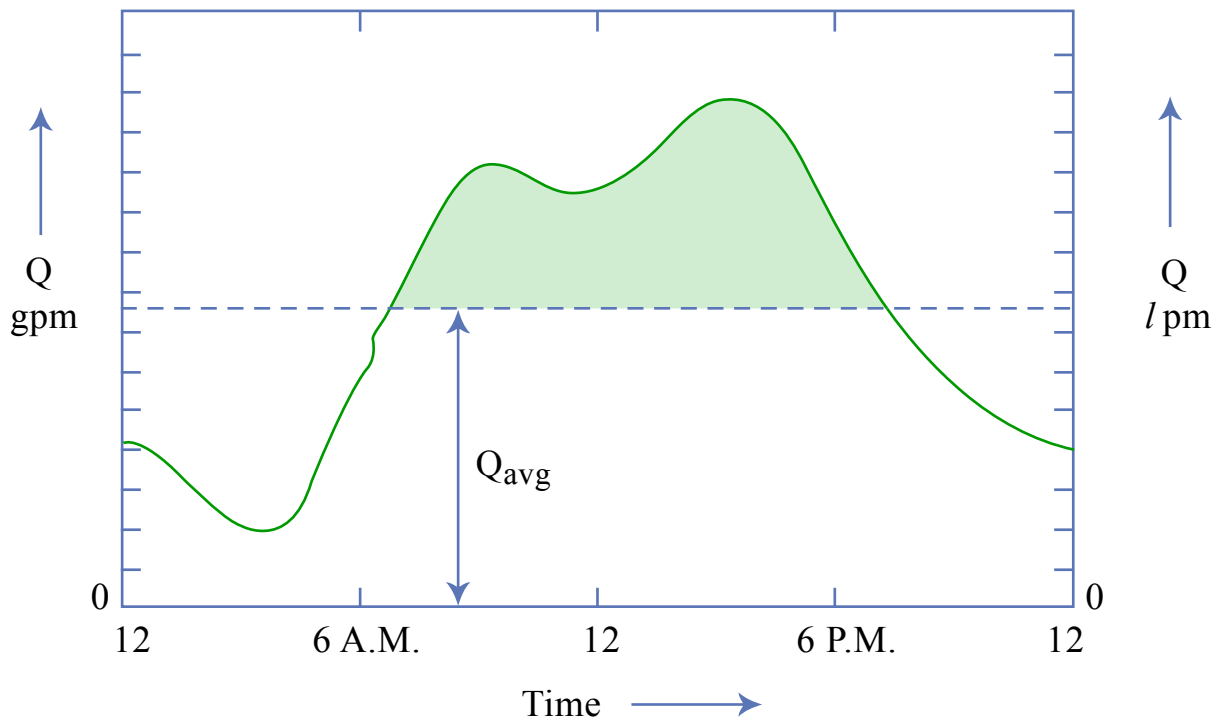
FLUCTUATING VOLUME DETERMINED BY HYDROGRAPH

Figure by MIT OCW.

Adapted from: Reynolds, T. D., and P. A. Richards. *Unit Operations and Processes In Environmental Engineering*. 2nd ed. Boston, MA: PWS Publishing Company, 1996.