

6.003: Signals and Systems

Feedback and Control

March 11, 2010

Feedback and Control

Feedback is pervasive in natural and artificial systems.

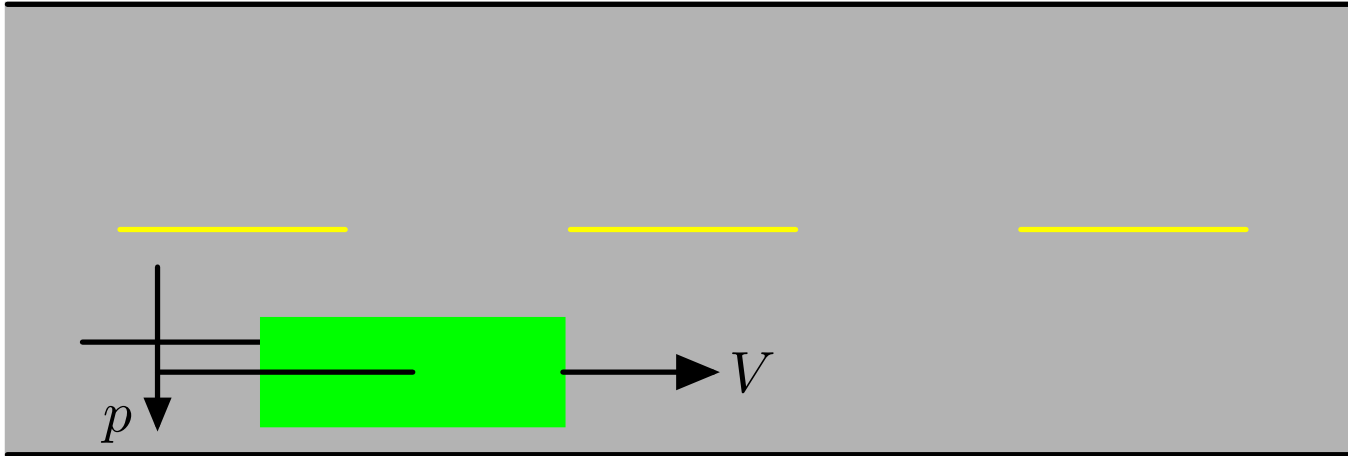

Turn steering wheel to stay centered in the lane.

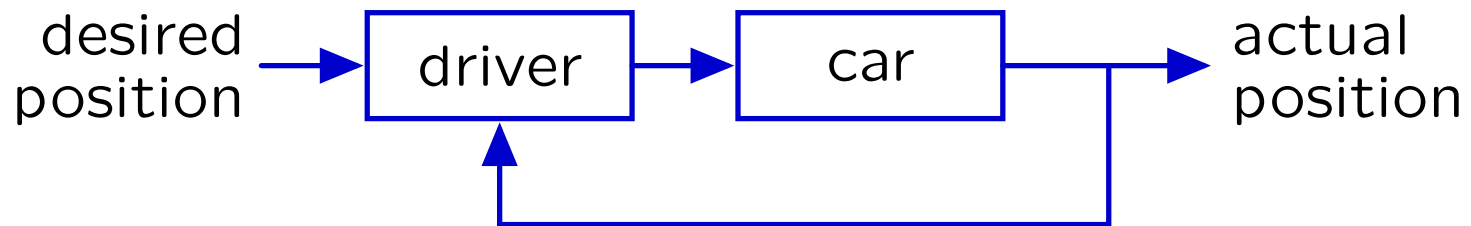

Feedback and Control

Concentration of glucose in blood is highly regulated and remains nearly constant despite episodic ingestion and use.

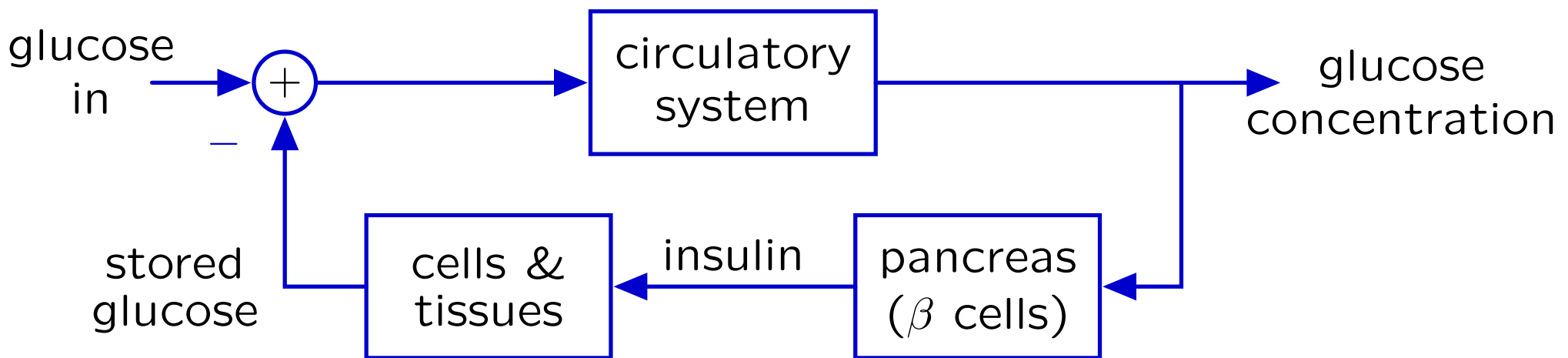
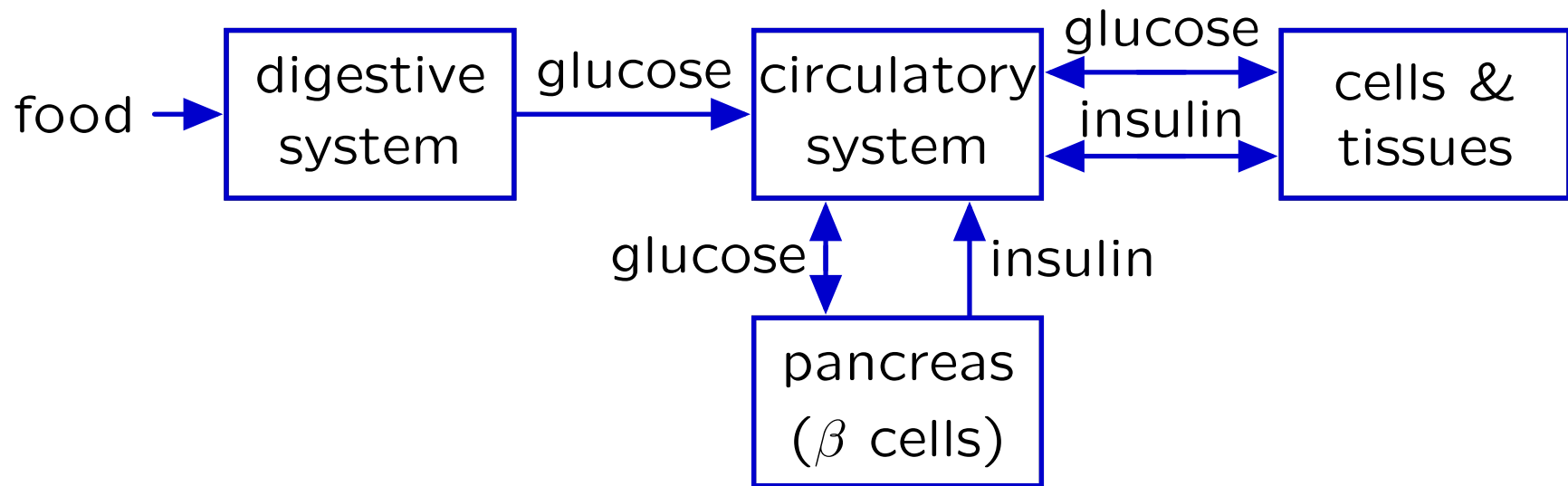

Today's goal

Use systems theory to gain insight into how to control a system.

Example: wallFinder System

Approach a wall, stopping a desired distance d_i in front of it.

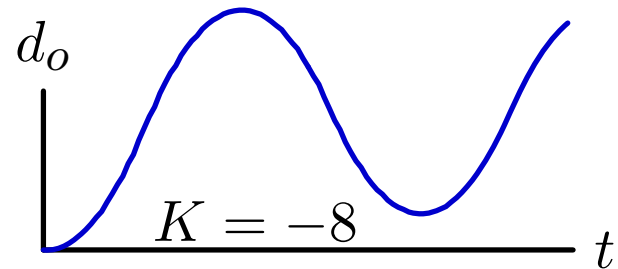
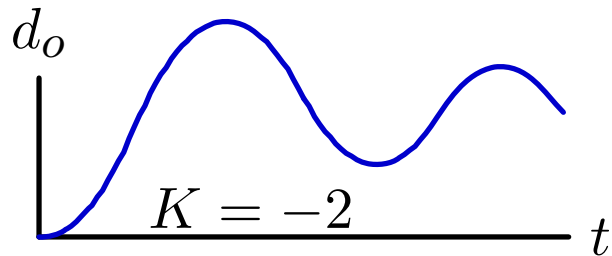
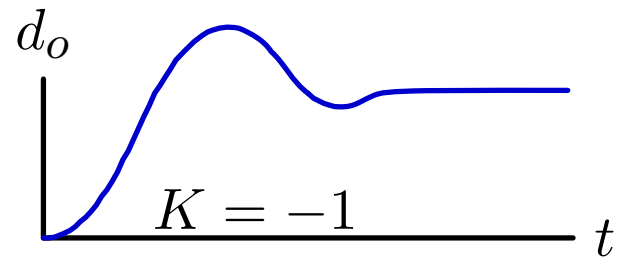
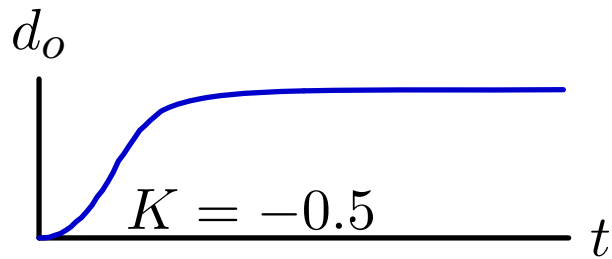
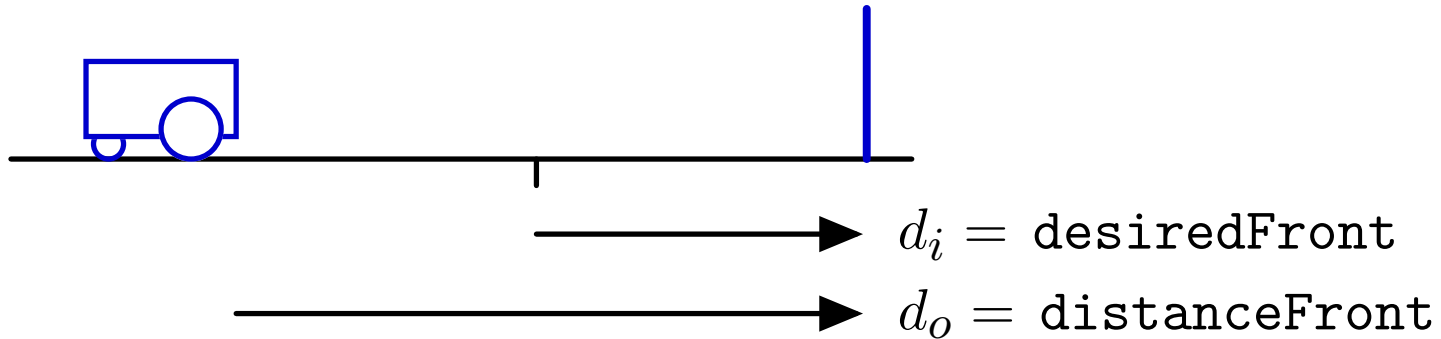

What causes these different types of responses?

Structure of a Control Problem

(Simple) Control systems have three parts.

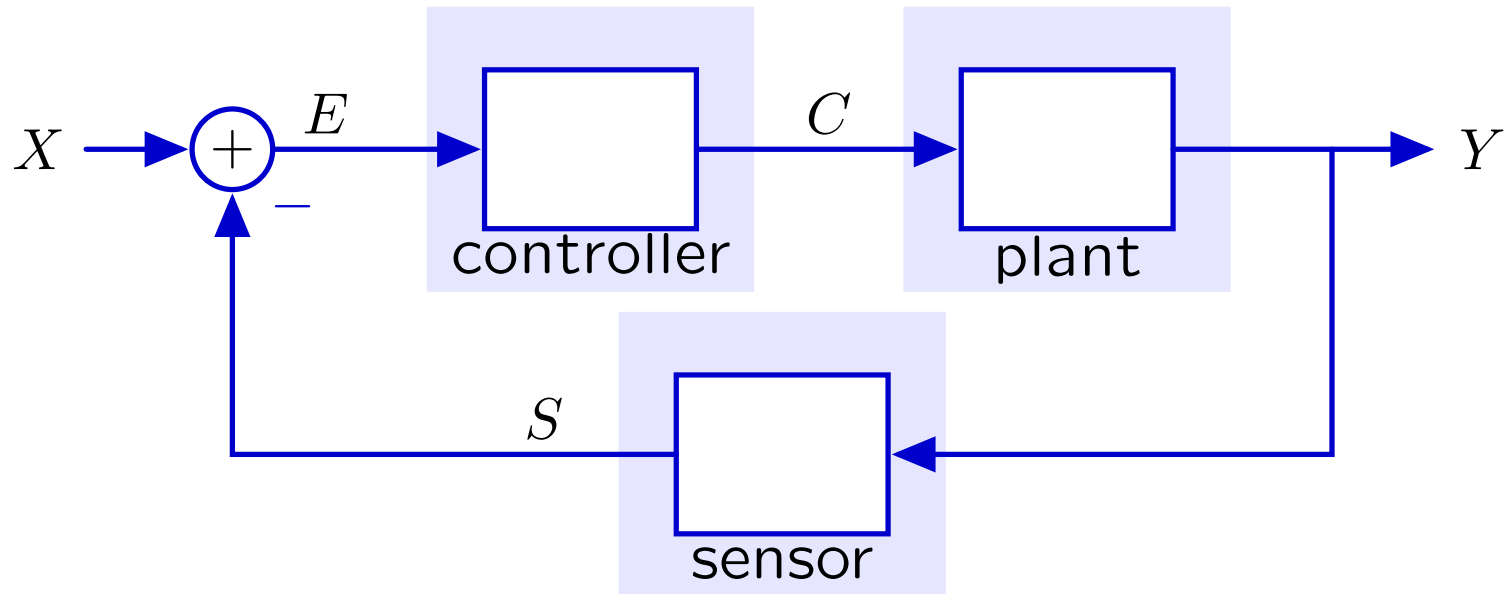

The **plant** is the system to be controlled.

The **sensor** measures the output of the plant.

The **controller** specifies a command C to the plant based on the *difference* between the input X and sensor output S .

Analysis of wallFinder System

Cast wallFinder problem into control structure.

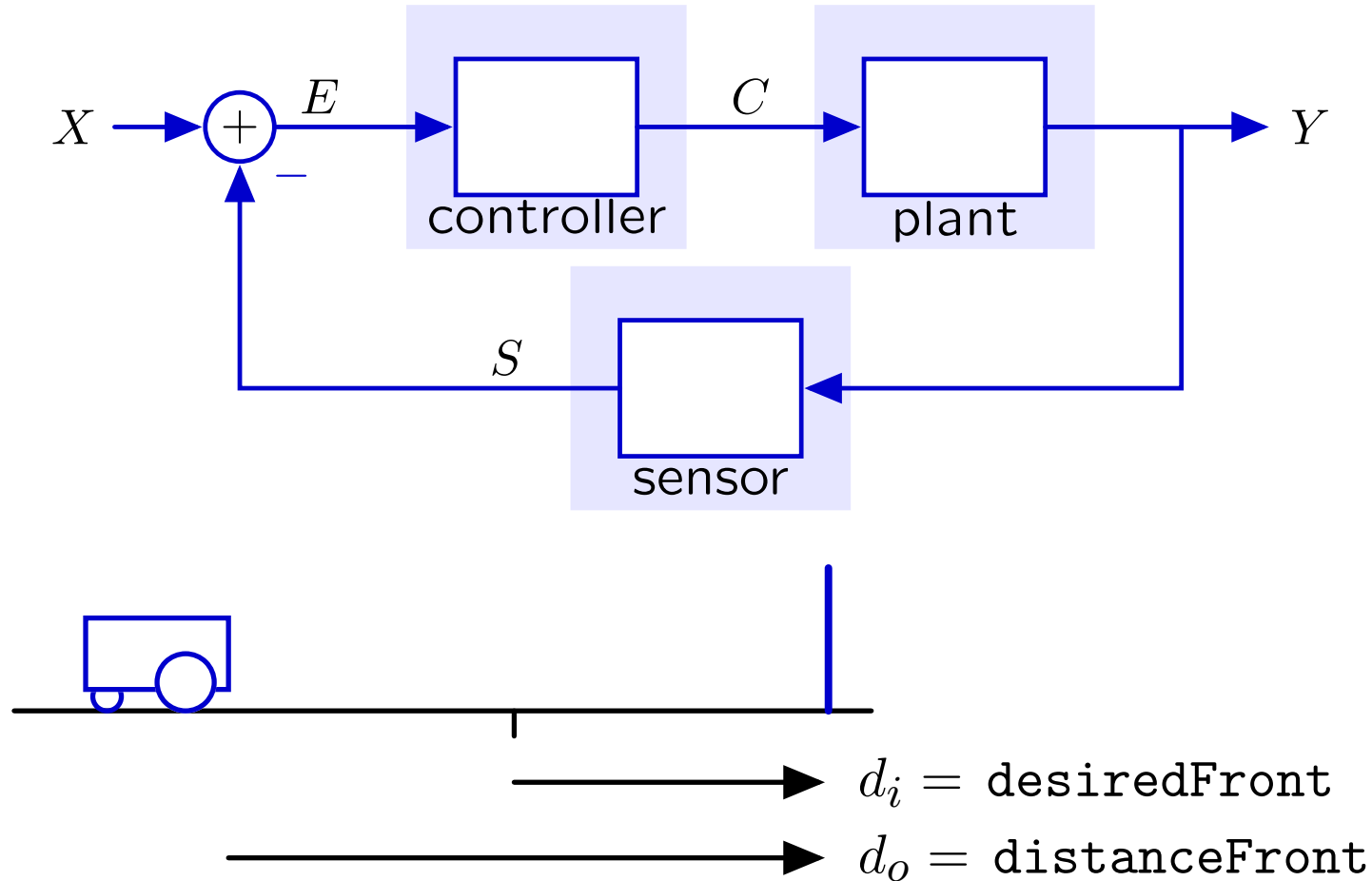

proportional controller: $v[n] = Ke[n] = K(d_i[n] - d_s[n])$

locomotion: $d_o[n] = d_o[n - 1] - Tv[n - 1]$

sensor with no delay: $d_s[n] = d_o[n]$

Analysis of wallFinder System: Block Diagram

Visualize as block diagram.

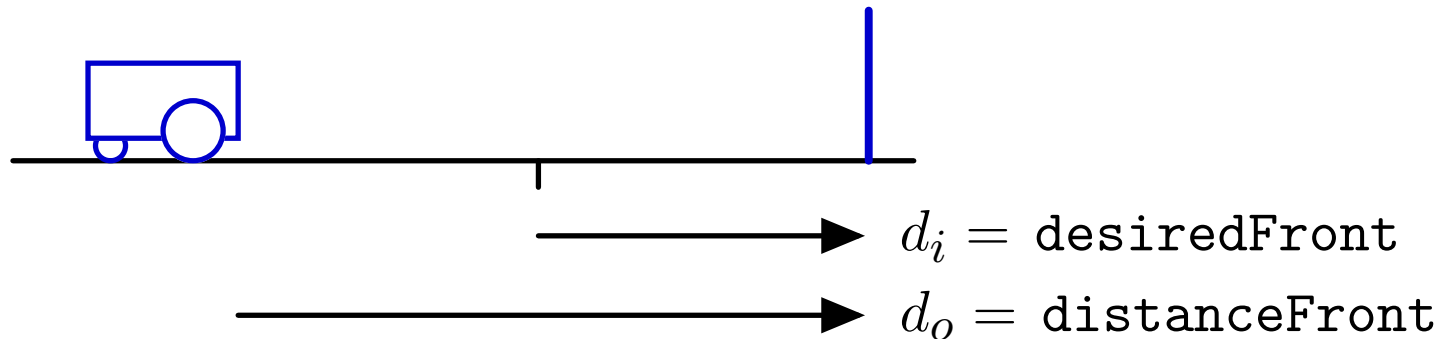

proportional controller: $v[n] = Ke[n] = K(d_i[n] - d_s[n])$

locomotion: $d_o[n] = d_o[n - 1] - Tv[n - 1]$

sensor with no delay: $d_s[n] = d_o[n]$

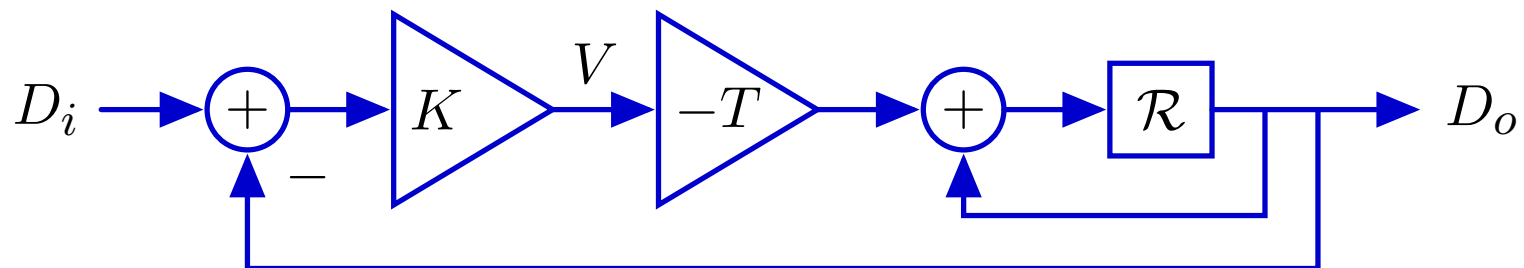

Analysis of wallFinder System: System Function

Solve.

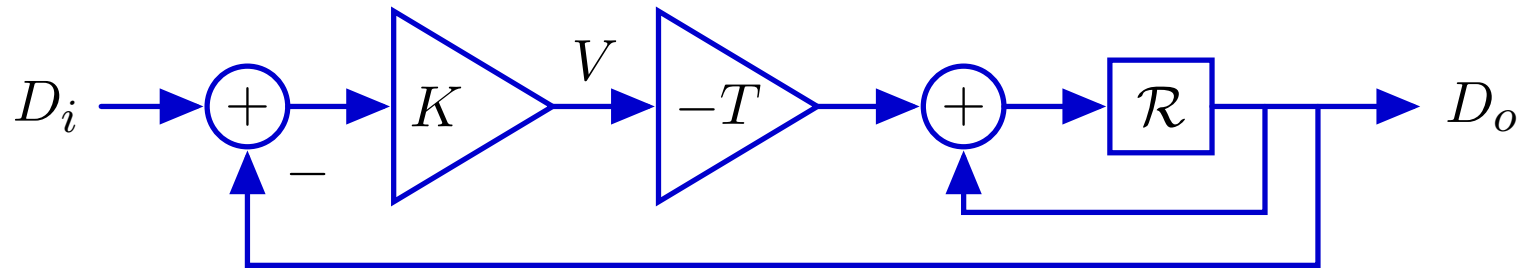
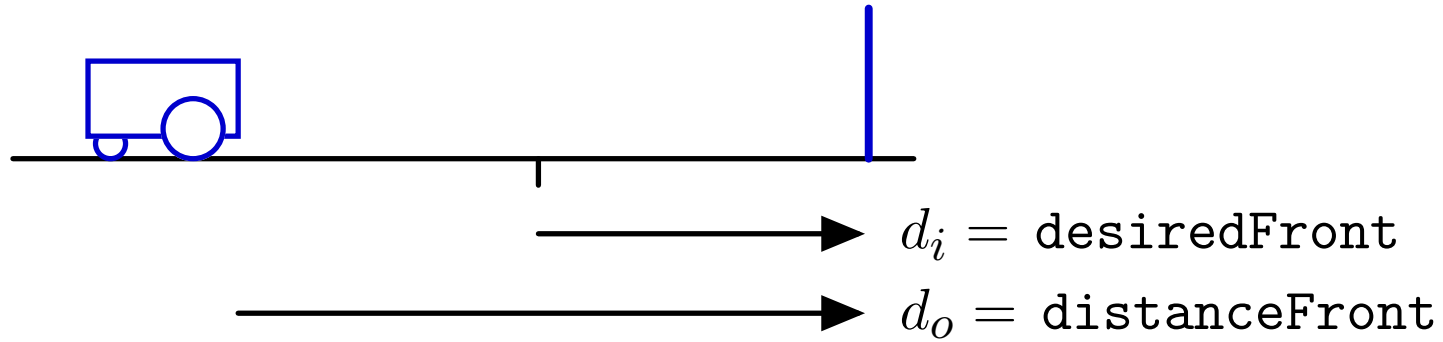

$$\frac{D_o}{D_i} = \frac{\frac{-KTR}{1 - \mathcal{R}}}{1 + \frac{-KTR}{1 - \mathcal{R}}} = \frac{-KTR}{1 - \mathcal{R} - KTR} = \frac{-KTR}{1 - (1 + KT)\mathcal{R}}$$

Analysis of wallFinder System: Poles

The system function contains a single **pole** at $z = 1 + KT$.

$$\frac{D_o}{D_i} = \frac{-KTR}{1 - (1 + KT)\mathcal{R}}$$

Unit-sample response for $KT = -0.2$:

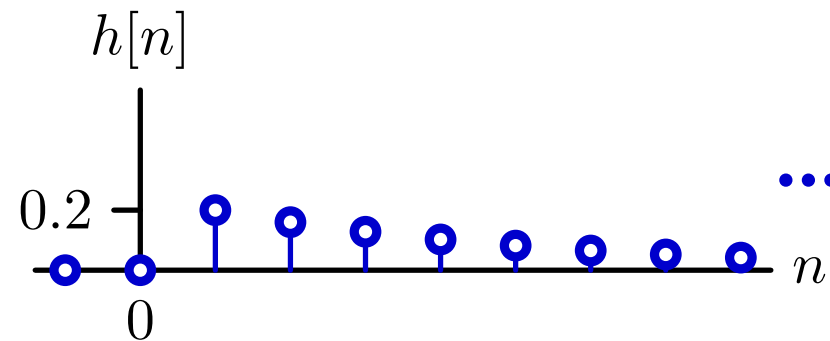

Unit-step response $s[n]$ for $KT = -0.2$:

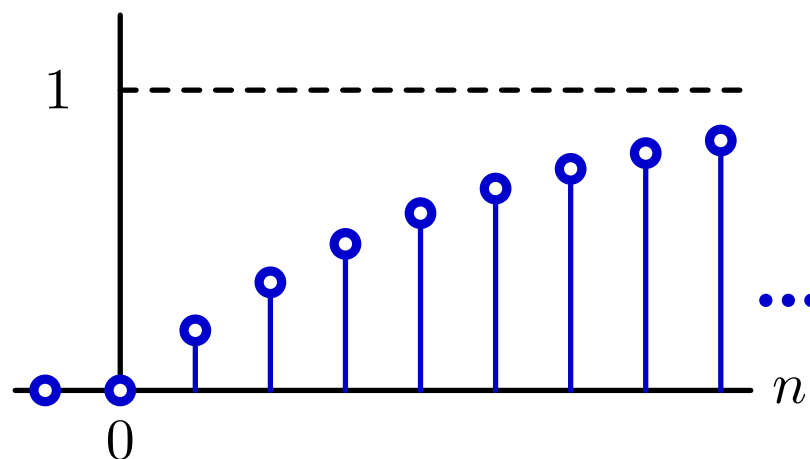

What determines the speed of the response? Could it be faster?

Check Yourself

Find KT for fastest convergence of unit-sample response.

$$\frac{D_o}{D_i} = \frac{-KTR}{1 - (1 + KT)\mathcal{R}}$$

1. $KT = -2$
2. $KT = -1$
3. $KT = 0$
4. $KT = 1$
5. $KT = 2$
0. none of the above

Check Yourself

Find KT for fastest convergence of unit-sample response.

$$\frac{D_o}{D_i} = \frac{-KTR}{1 - (1 + KT)\mathcal{R}}$$

If $KT = -1$ then the pole is at $z = 0$.

$$\frac{D_o}{D_i} = \frac{-KTR}{1 - (1 + KT)\mathcal{R}} = \mathcal{R}$$

Unit-sample response has a single non-zero output sample, at $n = 1$.

Analysis of wallFinder System: Poles

The poles of the system function provide insight for choosing K .

$$\frac{D_o}{D_i} = \frac{-KTR}{1 - (1 + KT)\mathcal{R}} = \frac{(1 - p_o)\mathcal{R}}{1 - p_o\mathcal{R}} ; \quad p_o = 1 + KT$$

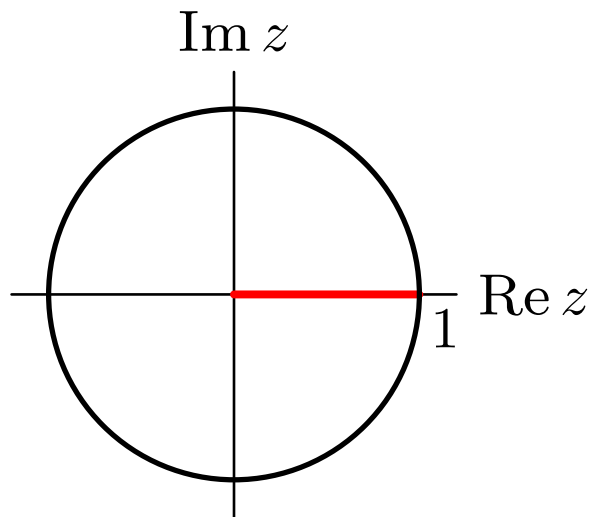

$0 < p_o < 1$
 $-1 < KT < 0$
monotonic
converging

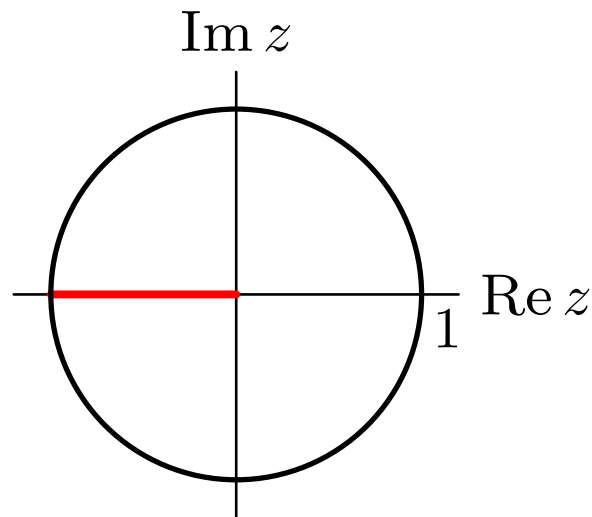

$-1 < p_o < 0$
 $-2 < KT < -1$
alternating
converging

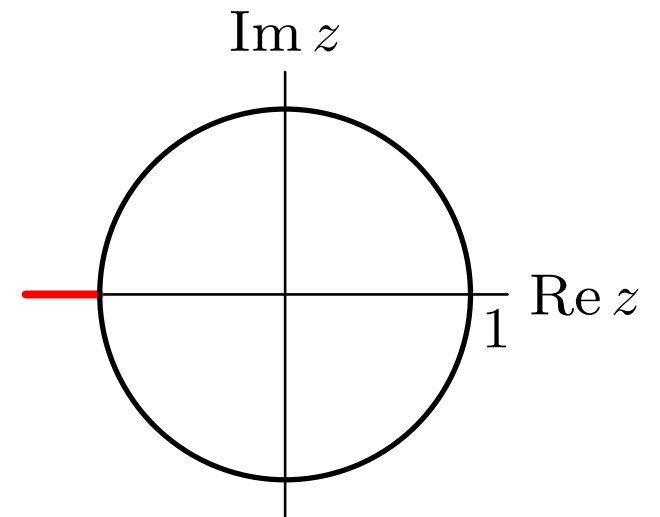

$p_o < -1$
 $KT < -2$
alternating
diverging

Check Yourself

Find KT for fastest convergence of unit-sample response.

$$\frac{D_o}{D_i} = \frac{-KTR}{1 - (1 + KT)\mathcal{R}}$$

1. $KT = -2$
2. $KT = -1$
3. $KT = 0$
4. $KT = 1$
5. $KT = 2$
0. none of the above

Analysis of wallFinder System

The optimum gain K moves robot to desired position in **one** step.

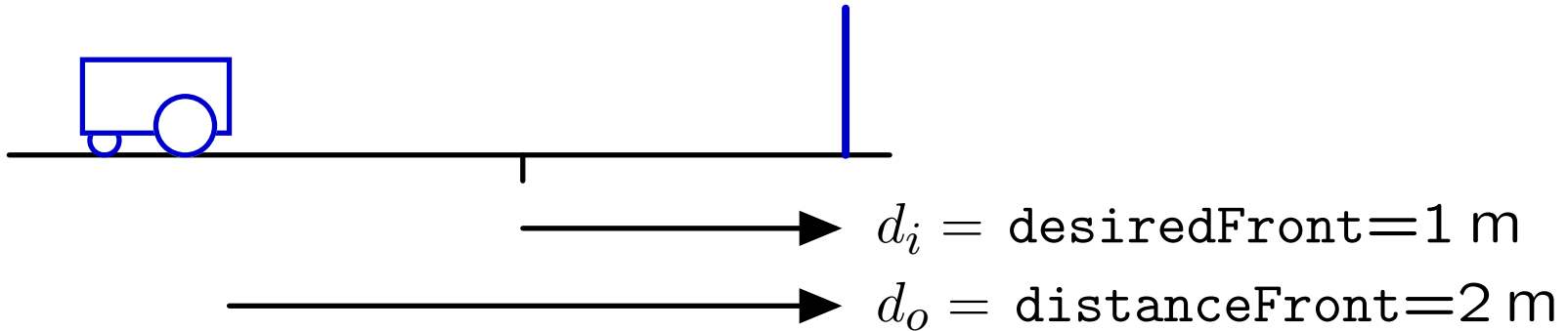

$$KT = -1$$

$$K = -\frac{1}{T} = -\frac{1}{1/10} = -10$$

$$v[n] = K(d_i[n] - d_o[n]) = -10(1 - 2) = 10 \text{ m/s}$$

exactly the right speed to get there in one step!

Analyzing wallFinder: Space-Time Diagram

The optimum gain K moves robot to desired position in **one** step.

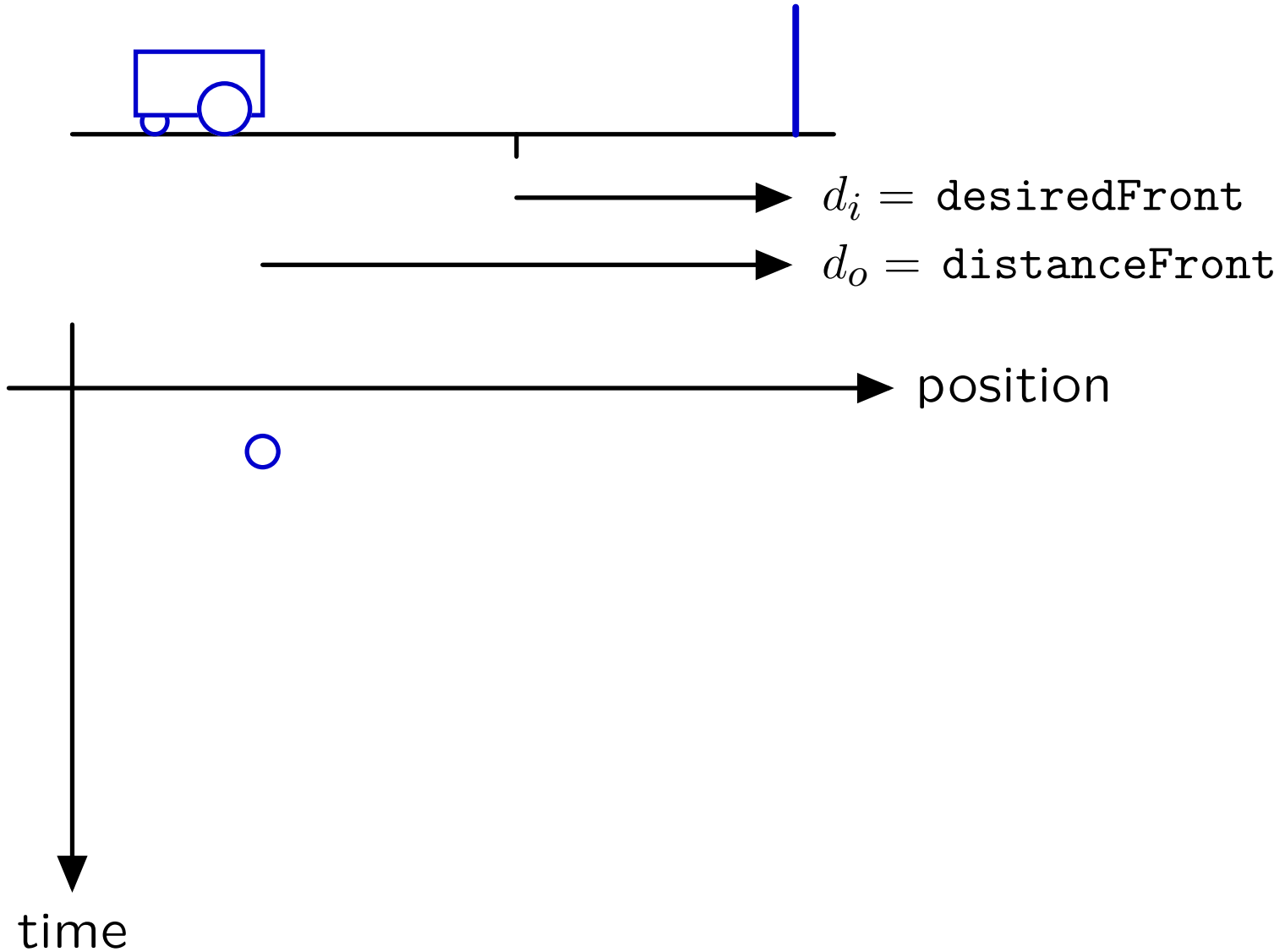

Analyzing wallFinder: Space-Time Diagram

The optimum gain K moves robot to desired position in **one** step.

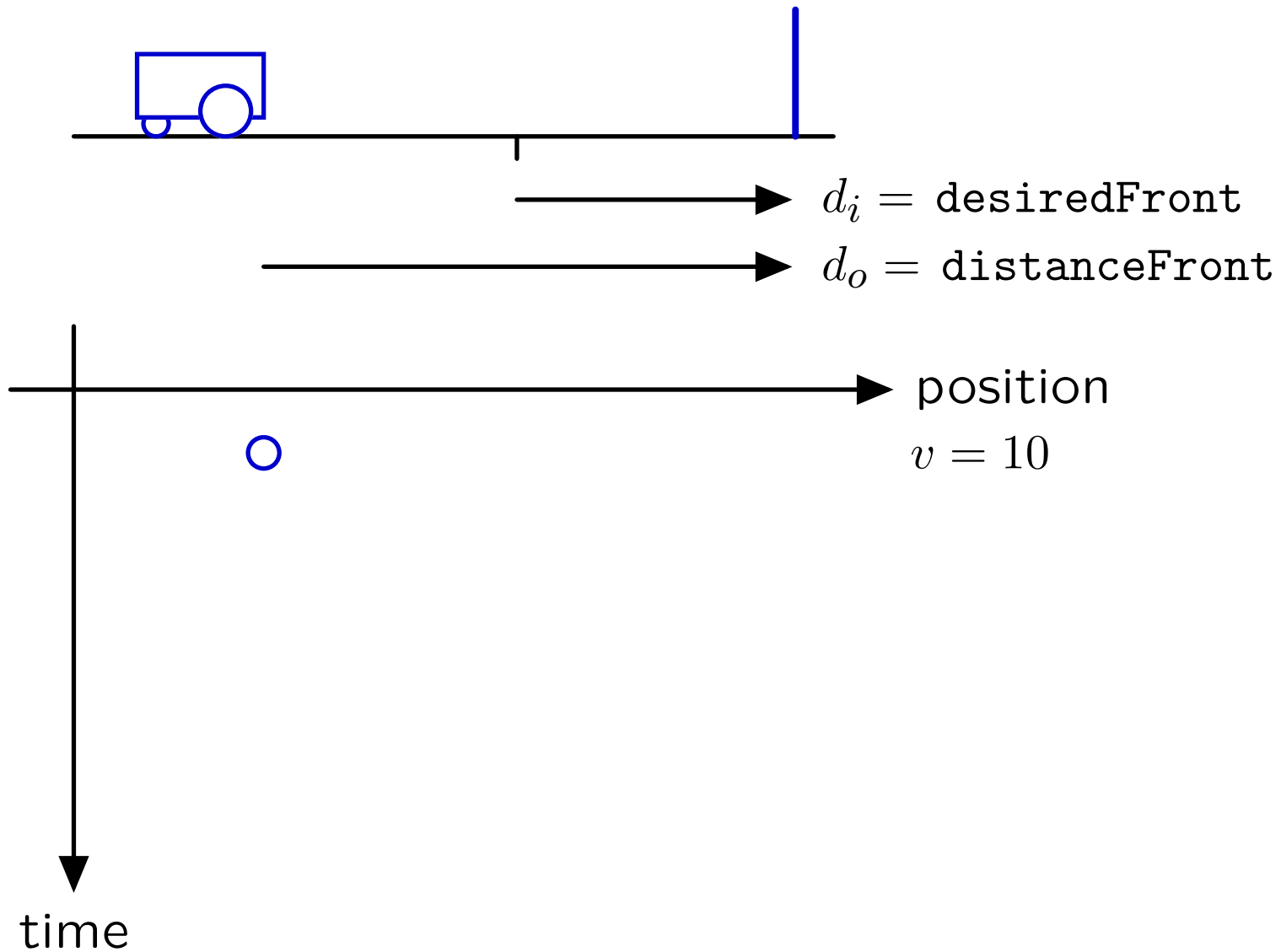

Analyzing wallFinder: Space-Time Diagram

The optimum gain K moves robot to desired position in **one** step.

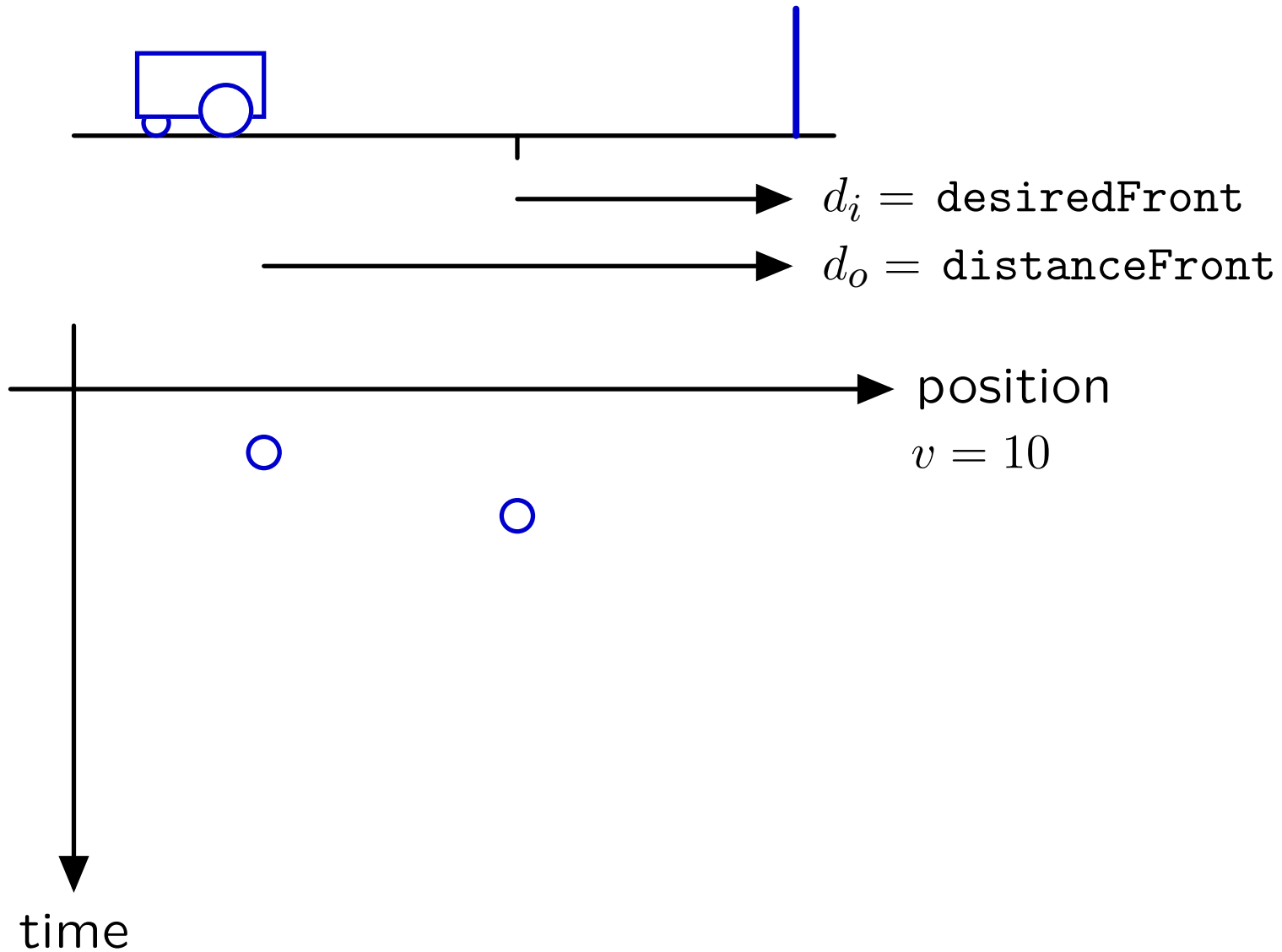

Analyzing wallFinder: Space-Time Diagram

The optimum gain K moves robot to desired position in **one** step.

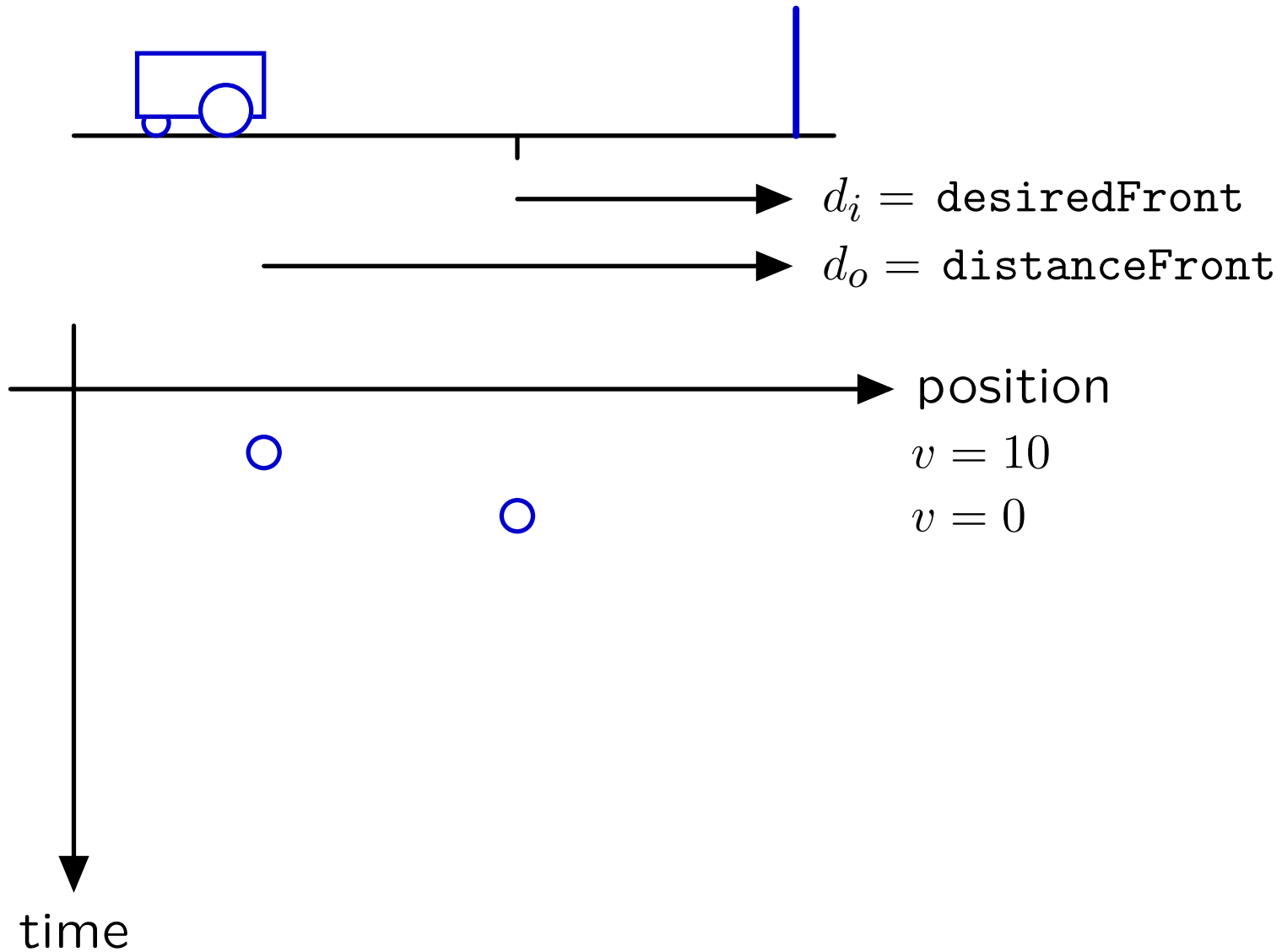

Analyzing wallFinder: Space-Time Diagram

The optimum gain K moves robot to desired position in **one** step.

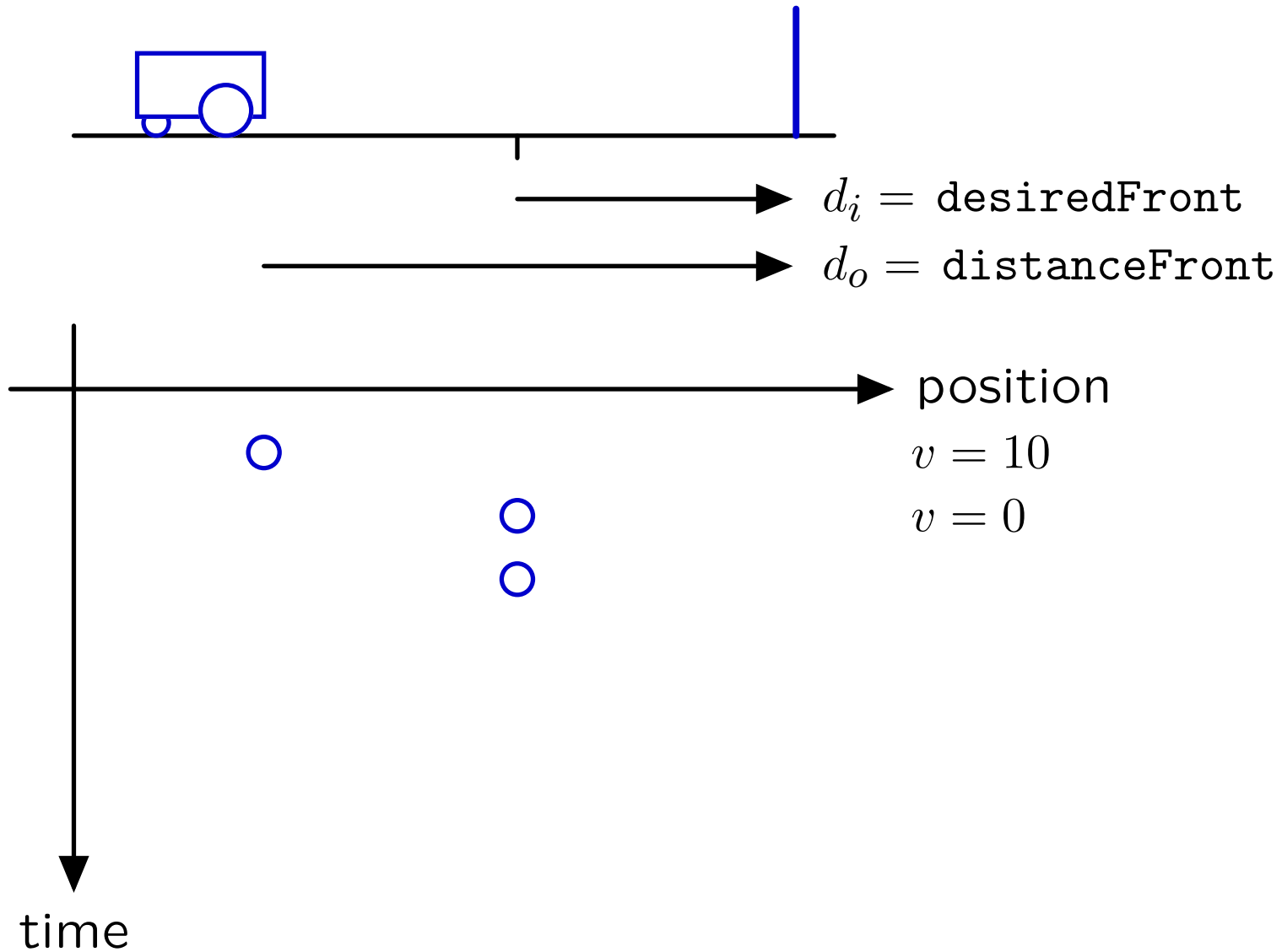

Analyzing wallFinder: Space-Time Diagram

The optimum gain K moves robot to desired position in **one** step.

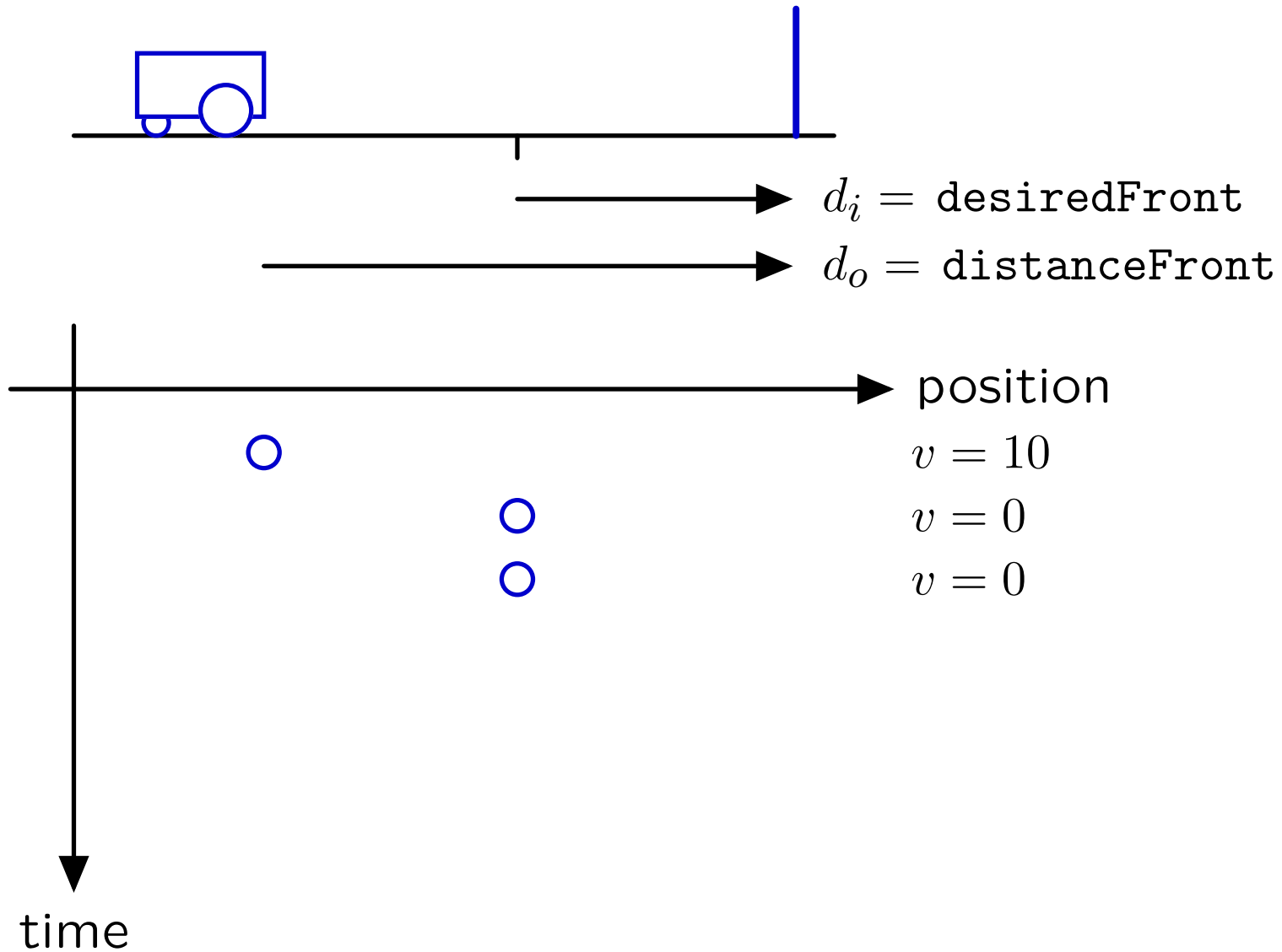

Analyzing wallFinder: Space-Time Diagram

The optimum gain K moves robot to desired position in **one** step.

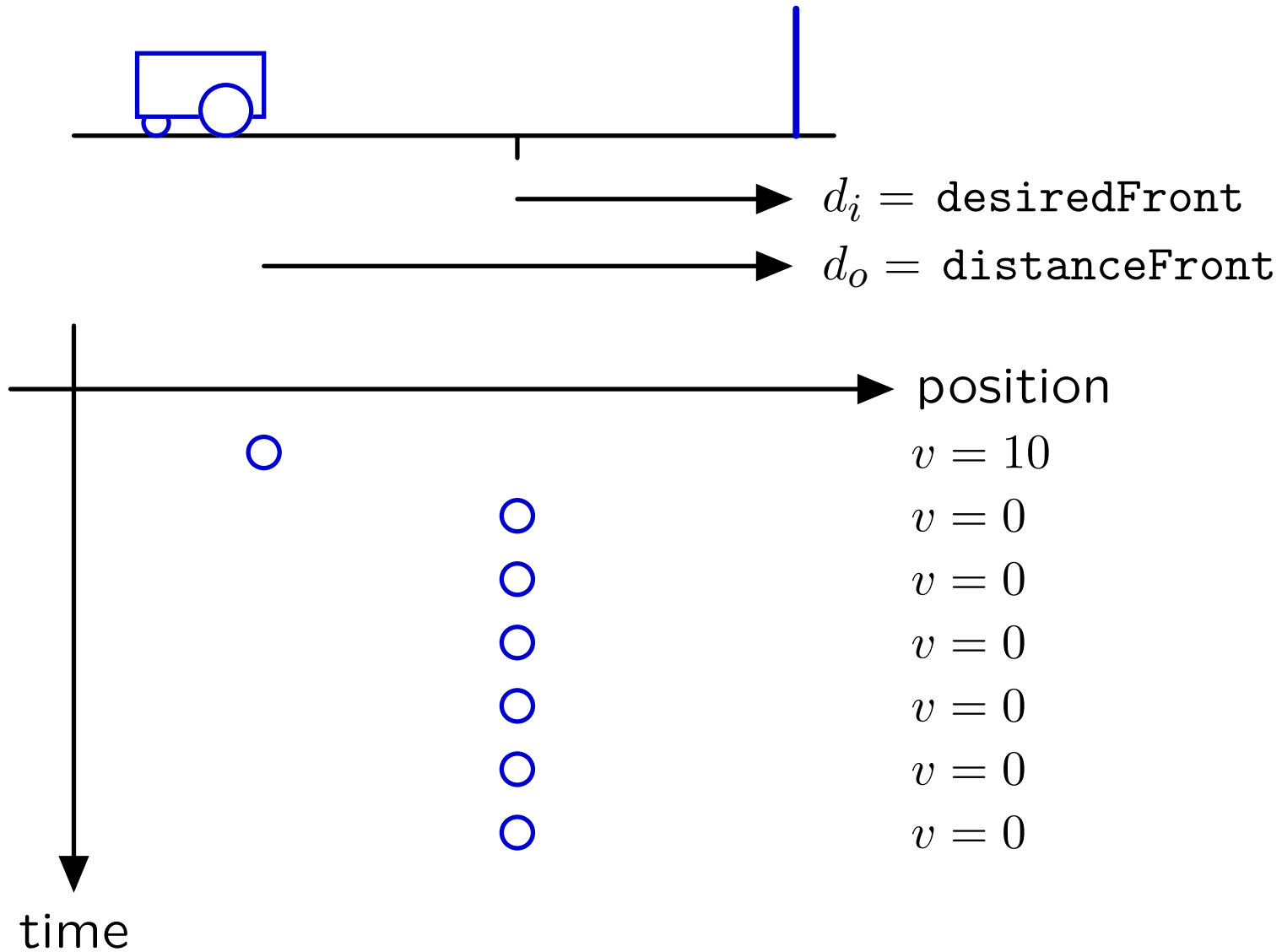

Analysis of wallFinder System: Adding Sensor Delay

Adding delay tends to destabilize control systems.

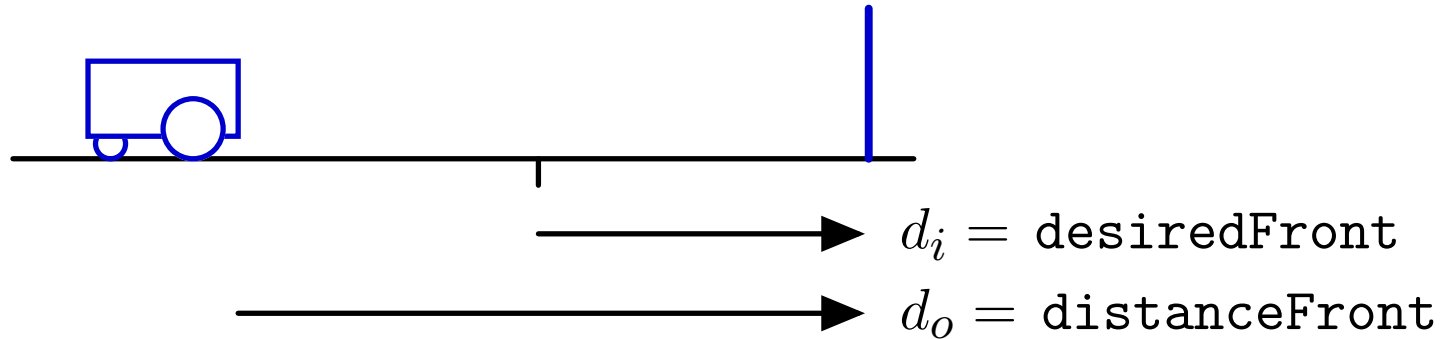

proportional controller: $v[n] = Ke[n] = K(d_i[n] - d_s[n])$

locomotion: $d_o[n] = d_o[n - 1] - Tv[n - 1]$

sensor **with delay**: $d_s[n] = d_o[\mathbf{n} - \mathbf{1}]$

Analysis of wallFinder System: Adding Sensor Delay

Adding delay tends to destabilize control systems.

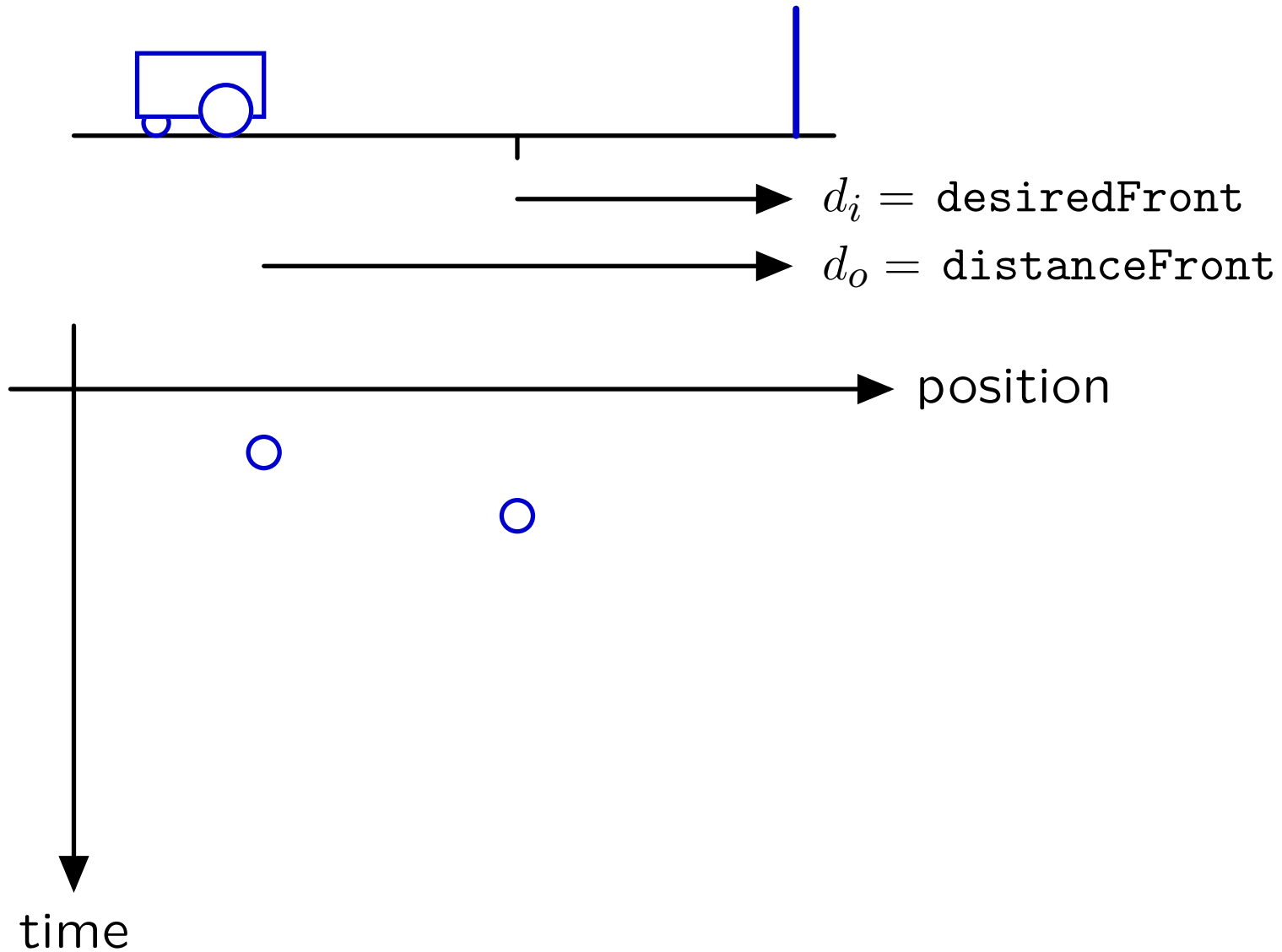

Analysis of wallFinder System: Adding Sensor Delay

Adding delay tends to destabilize control systems.

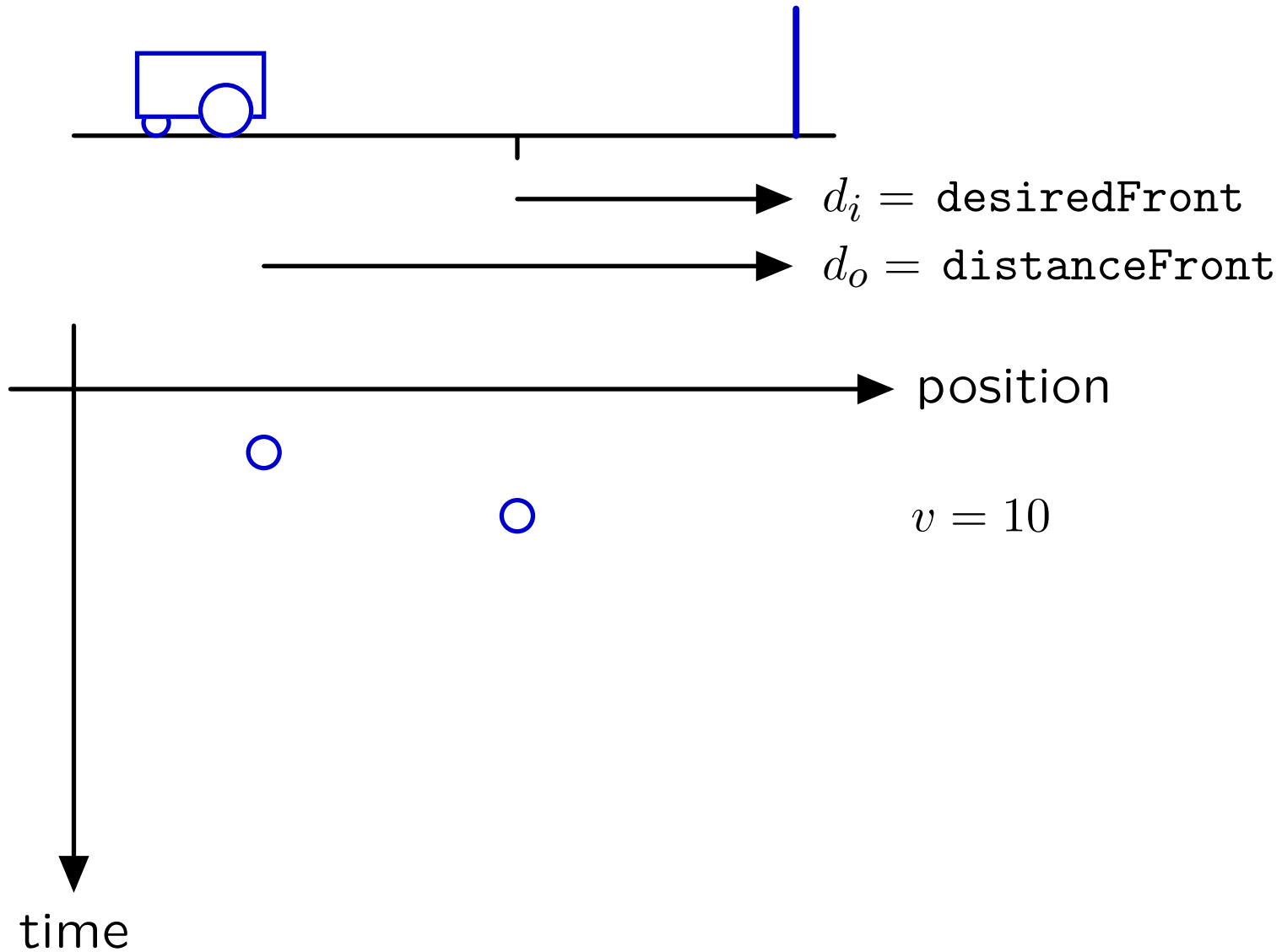

Analysis of wallFinder System: Adding Sensor Delay

Adding delay tends to destabilize control systems.

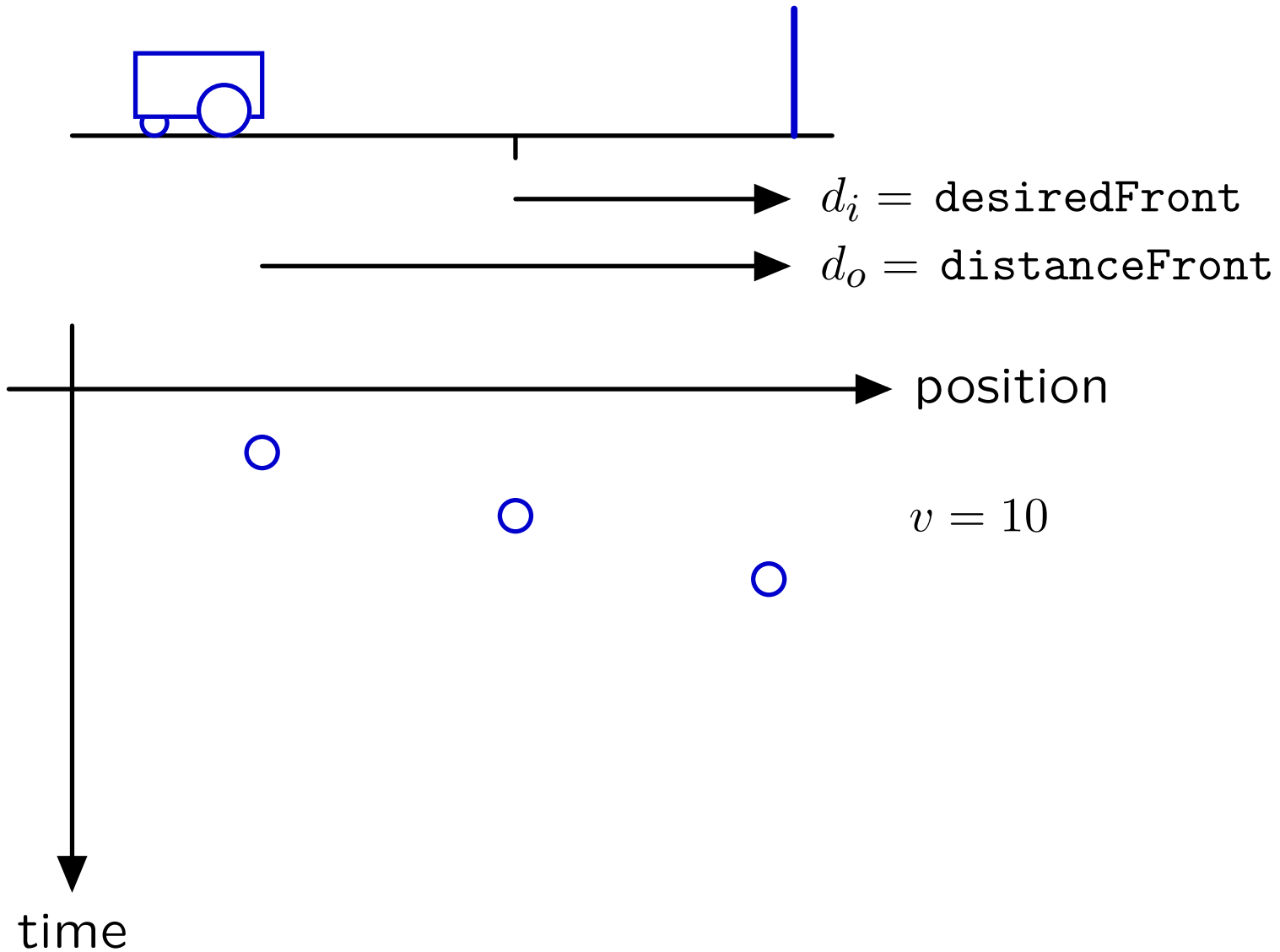

Analysis of wallFinder System: Adding Sensor Delay

Adding delay tends to destabilize control systems.

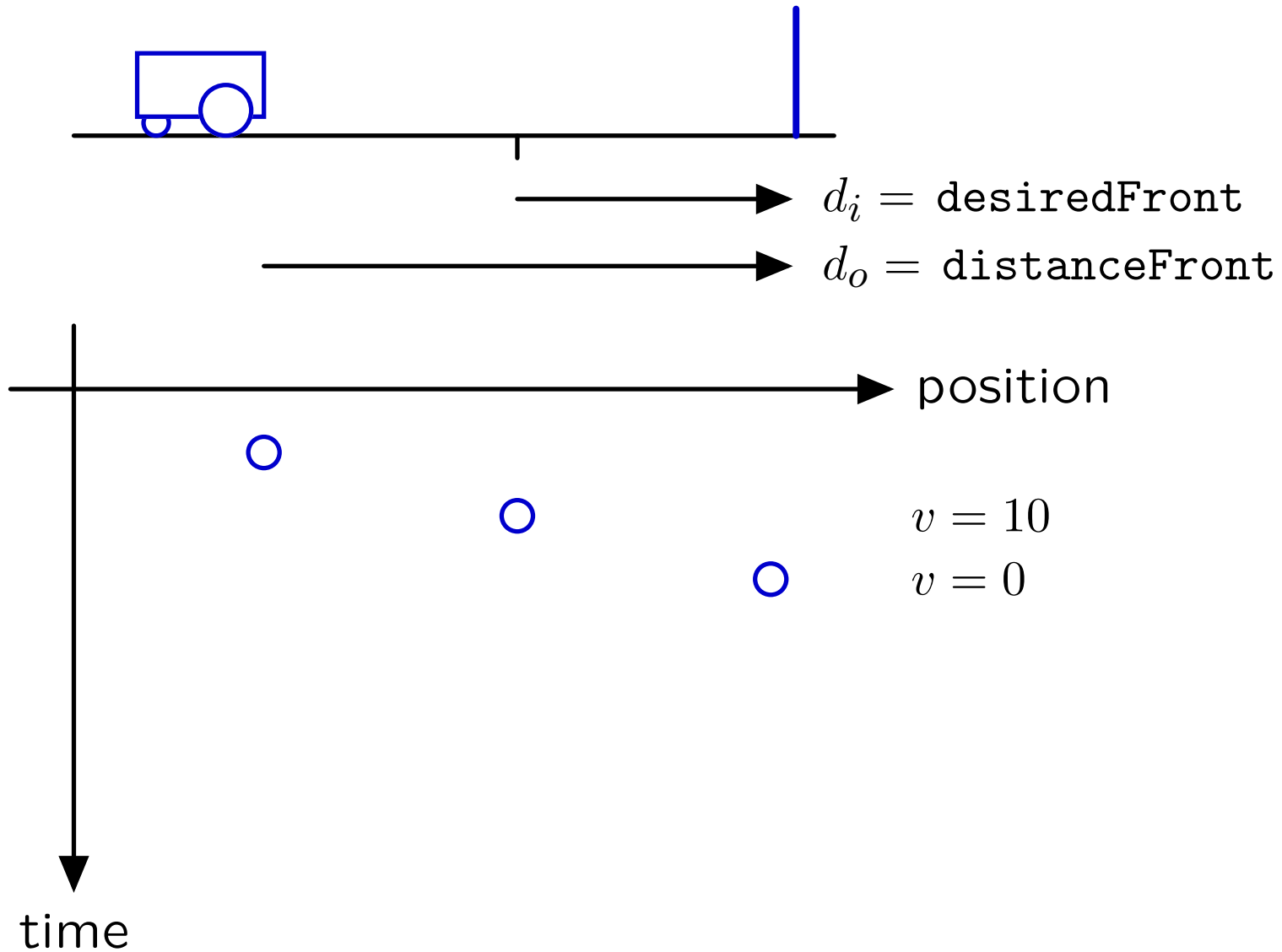

Analysis of wallFinder System: Adding Sensor Delay

Adding delay tends to destabilize control systems.

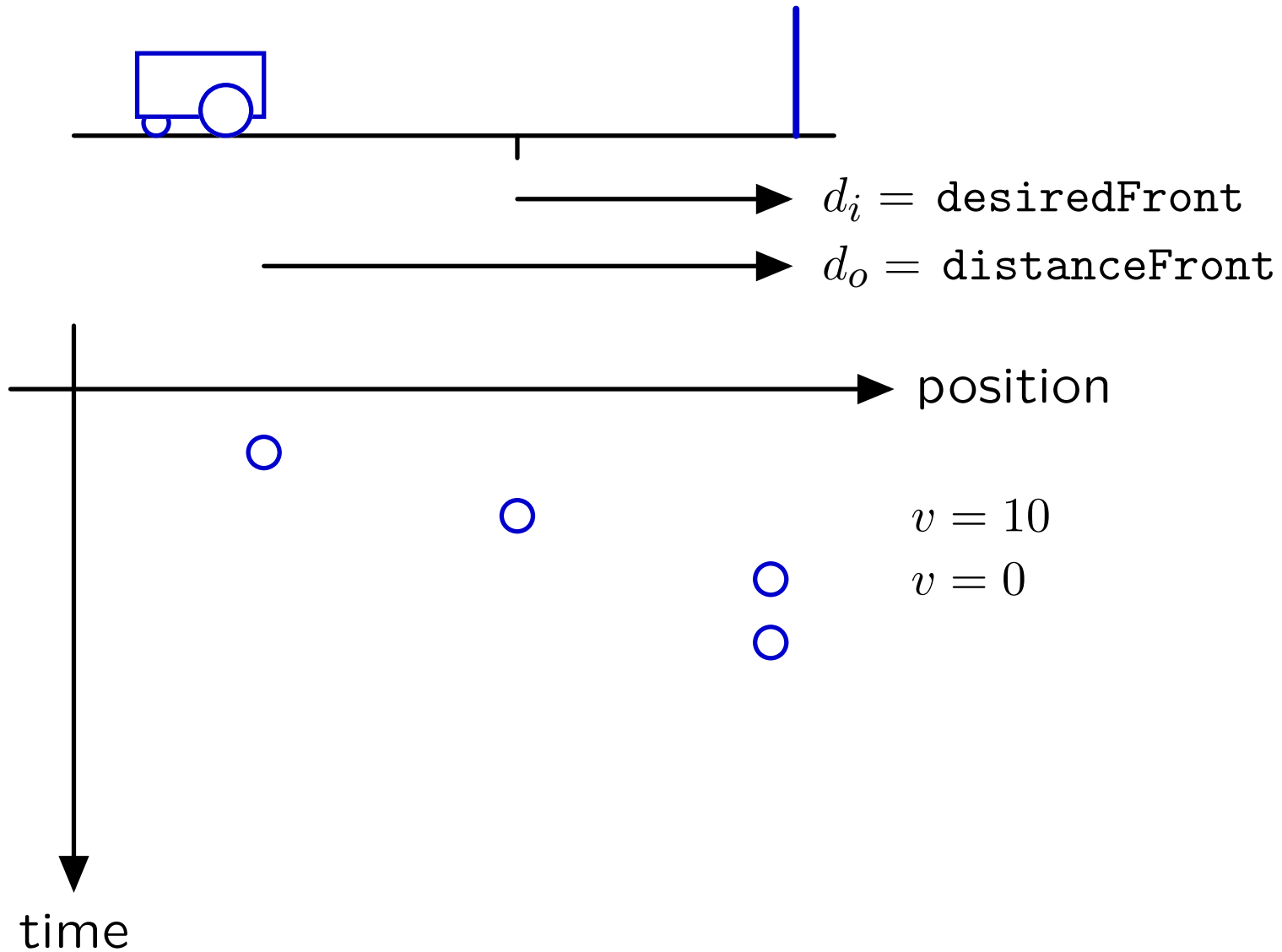

Analysis of wallFinder System: Adding Sensor Delay

Adding delay tends to destabilize control systems.

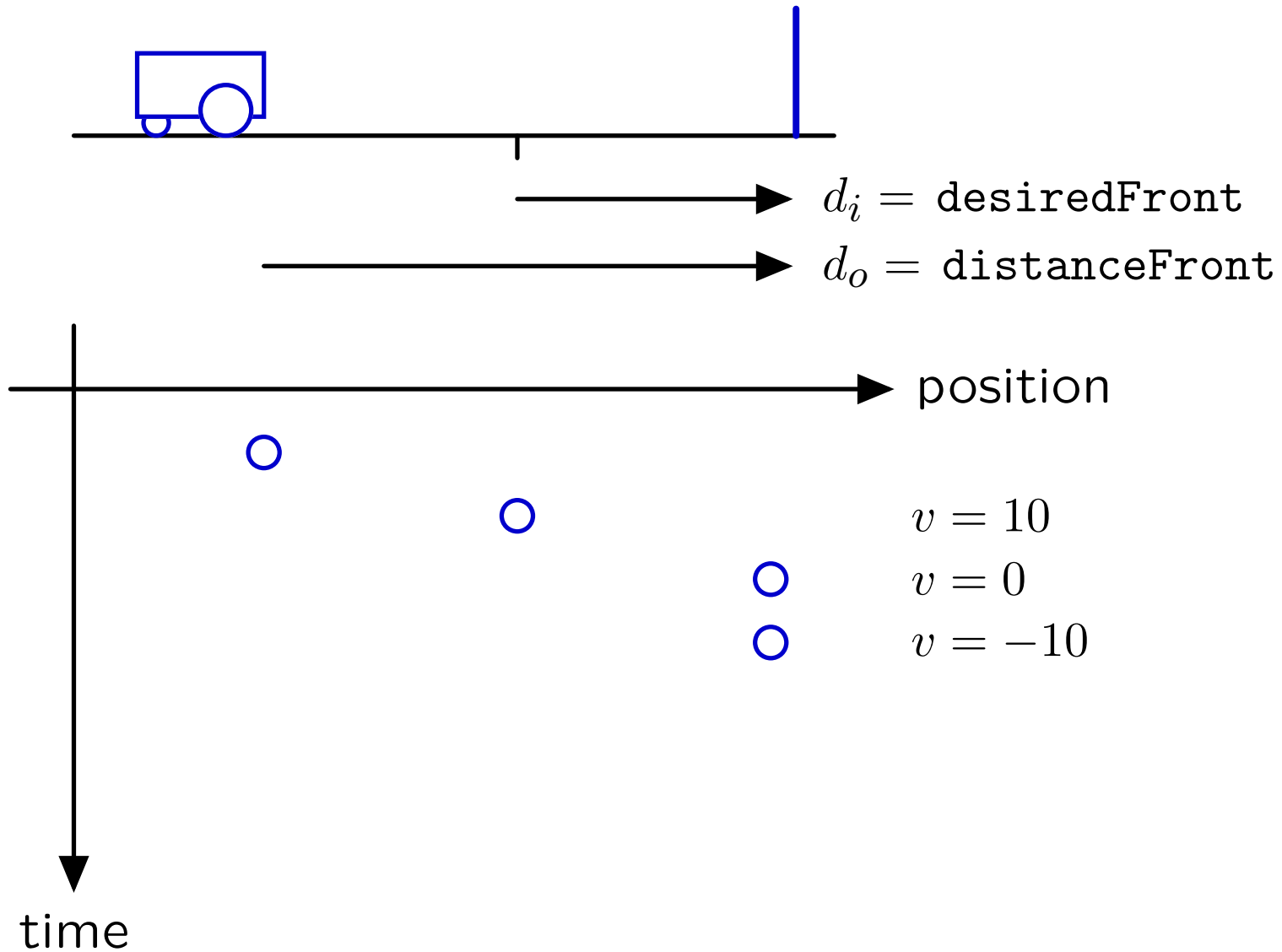

Analysis of wallFinder System: Adding Sensor Delay

Adding delay tends to destabilize control systems.

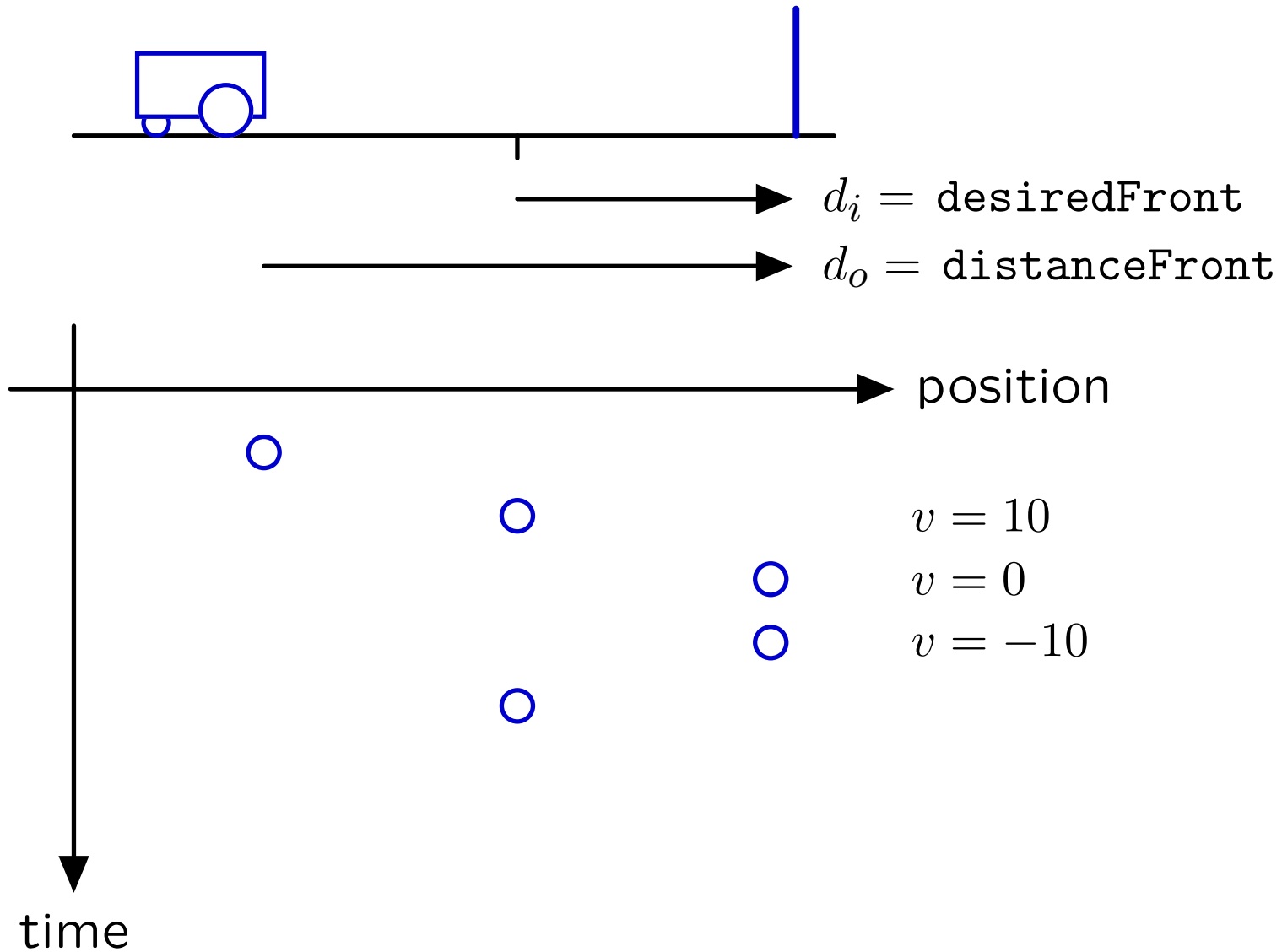

Analysis of wallFinder System: Adding Sensor Delay

Adding delay tends to destabilize control systems.

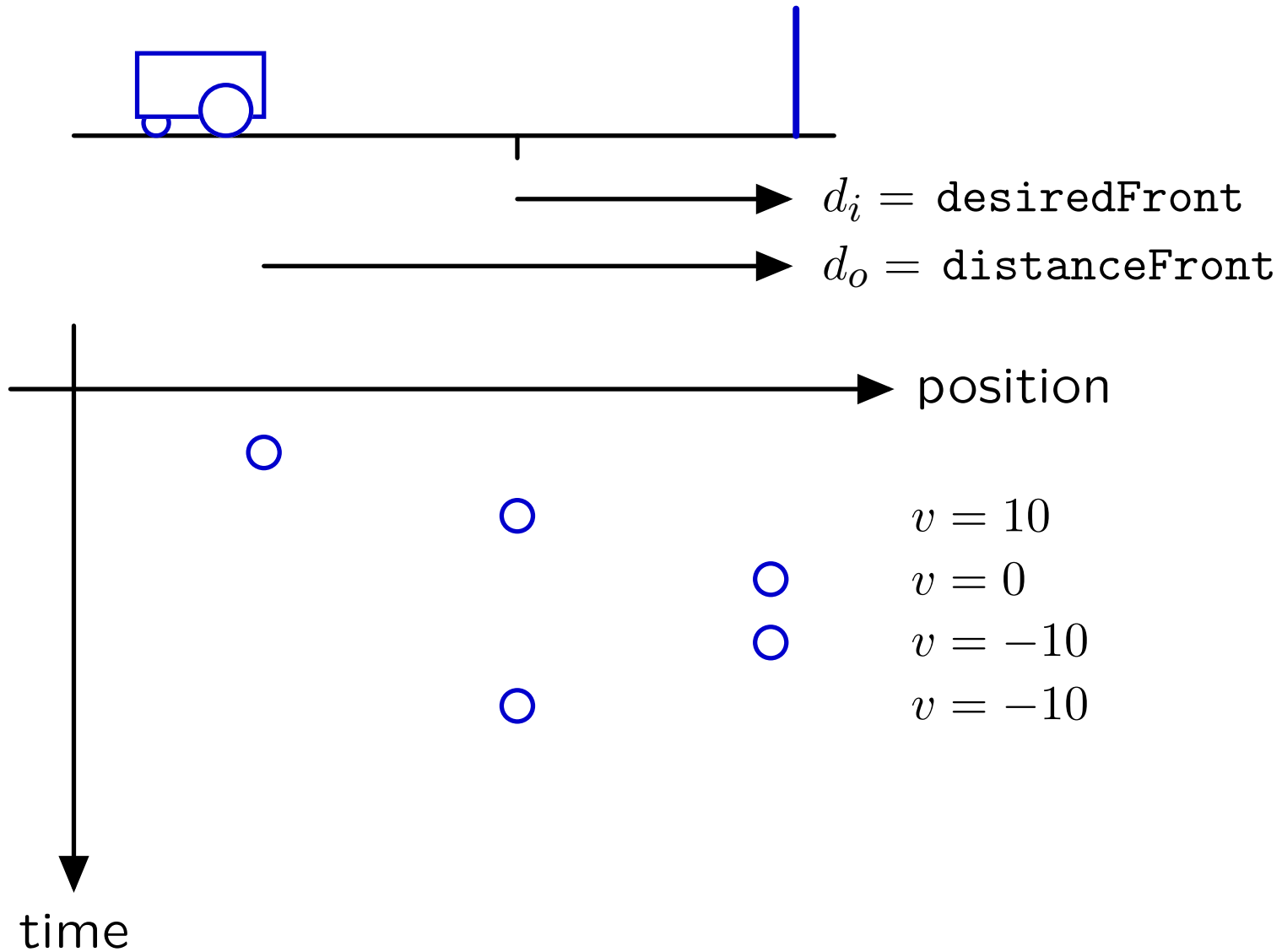

Analysis of wallFinder System: Adding Sensor Delay

Adding delay tends to destabilize control systems.

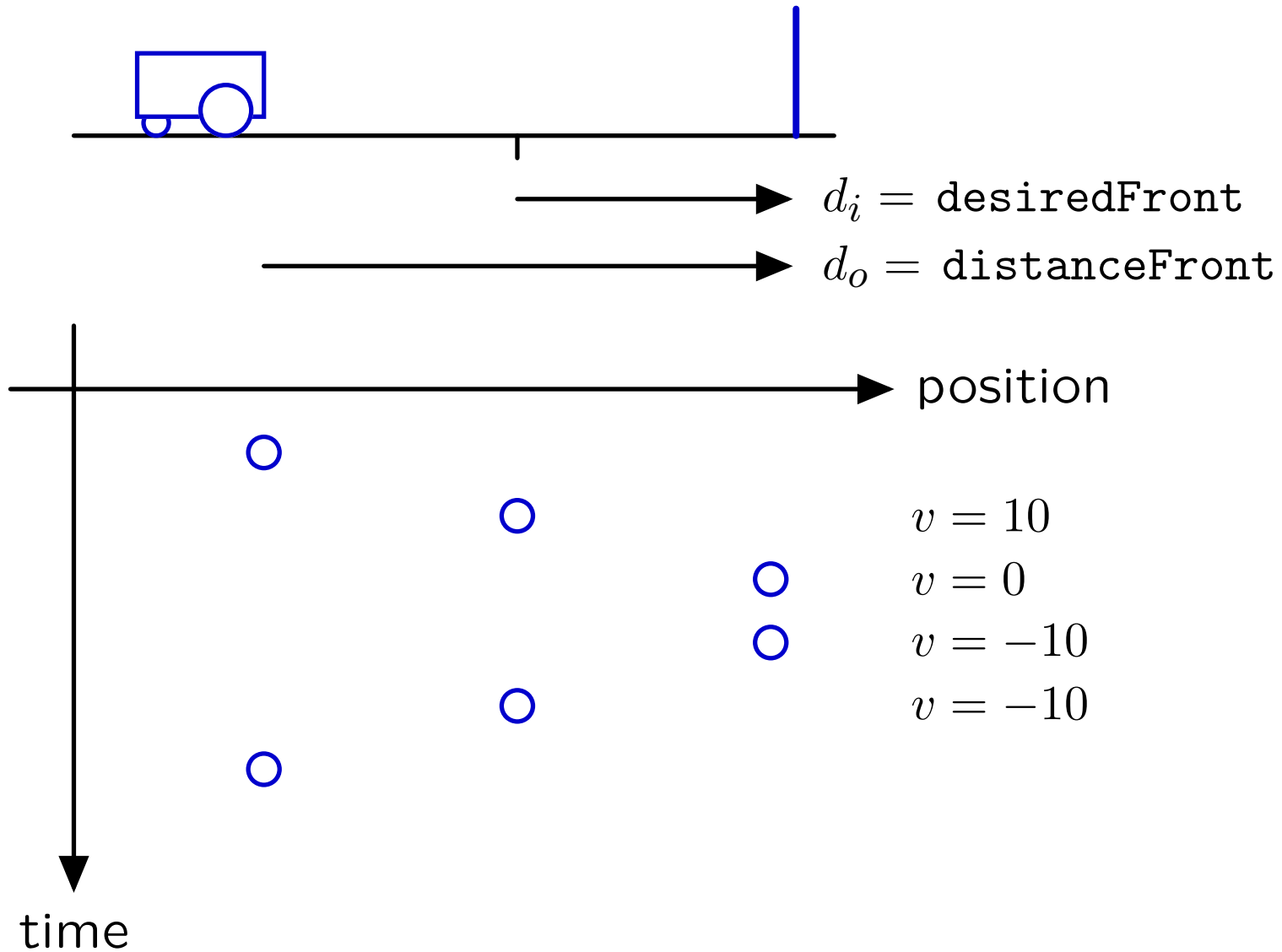

Analysis of wallFinder System: Adding Sensor Delay

Adding delay tends to destabilize control systems.

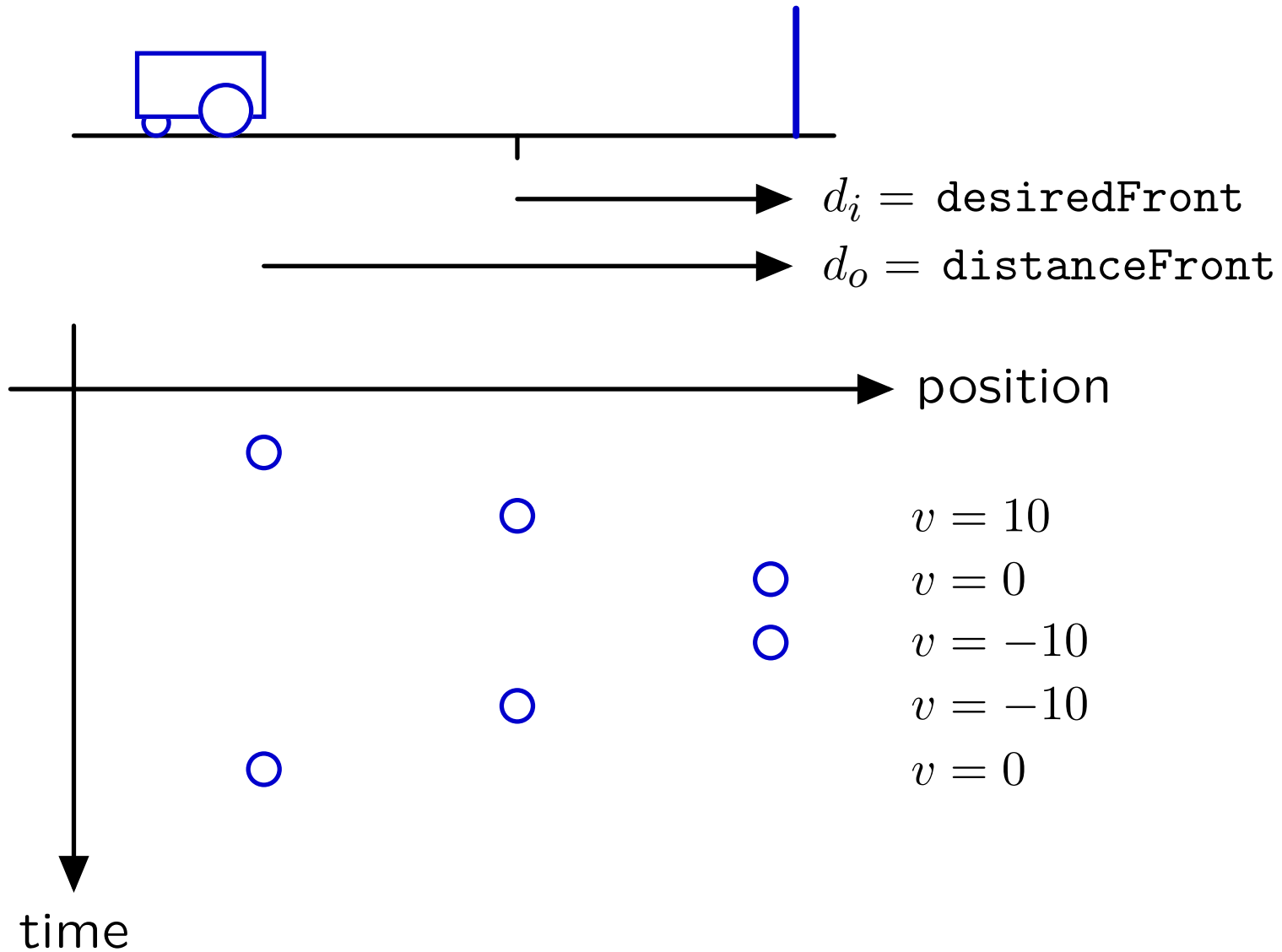

Analysis of wallFinder System: Adding Sensor Delay

Adding delay tends to destabilize control systems.

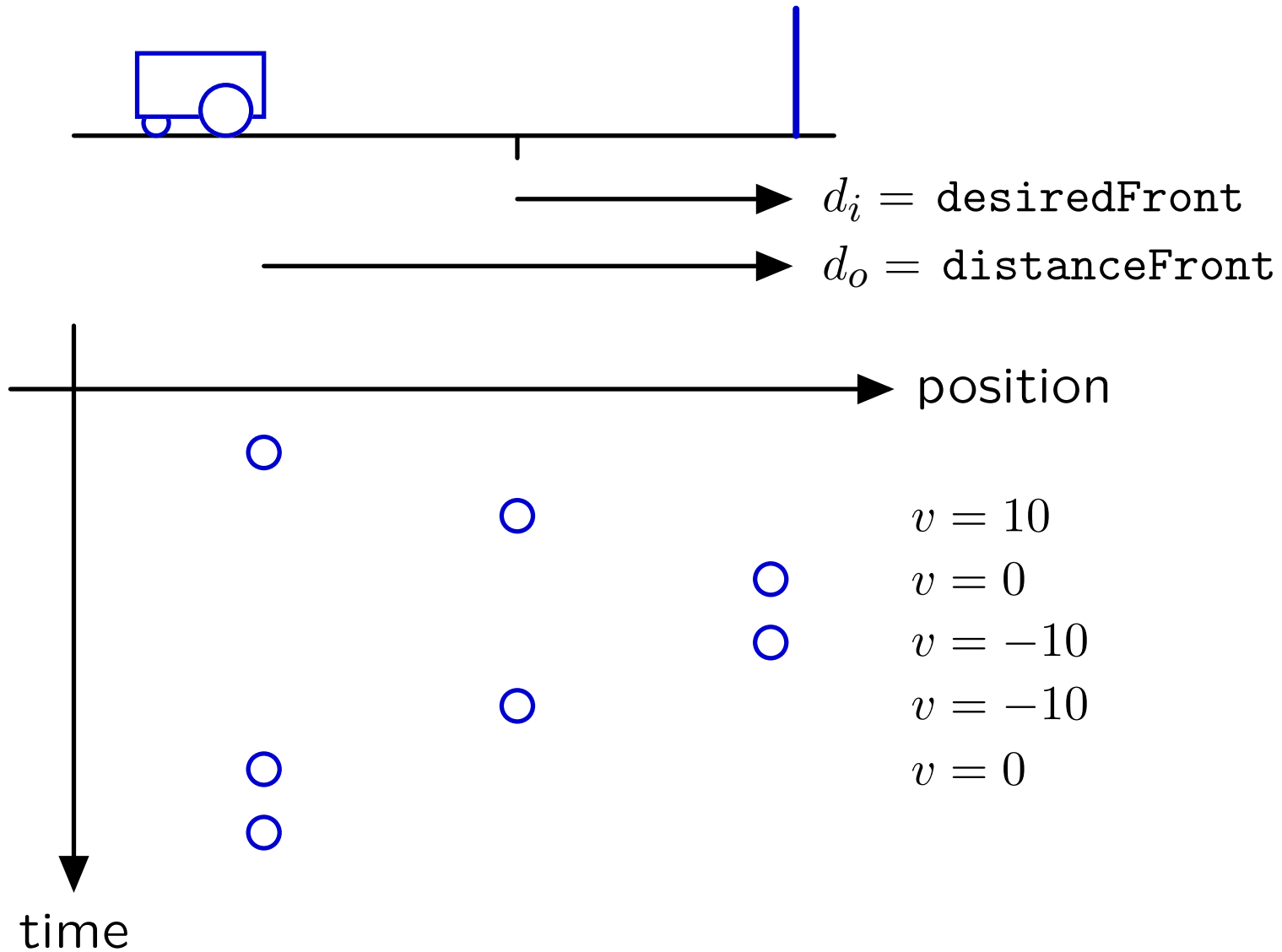

Analysis of wallFinder System: Block Diagram

Incorporating sensor delay in block diagram.

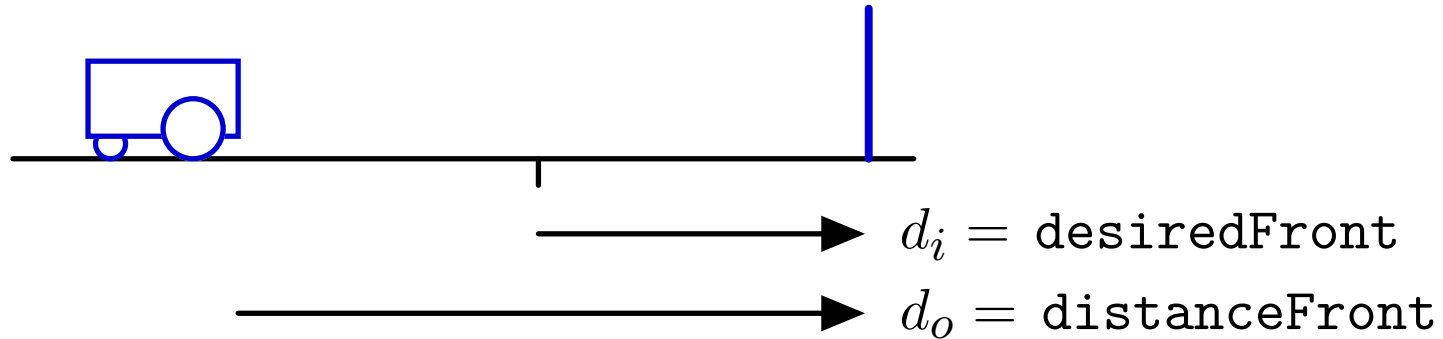

proportional controller: $v[n] = Ke[n] = K(d_i[n] - d_s[n])$

locomotion: $d_o[n] = d_o[n - 1] - Tv[n - 1]$

sensor with no delay: $d_s[n] = d_o[n - 1]$

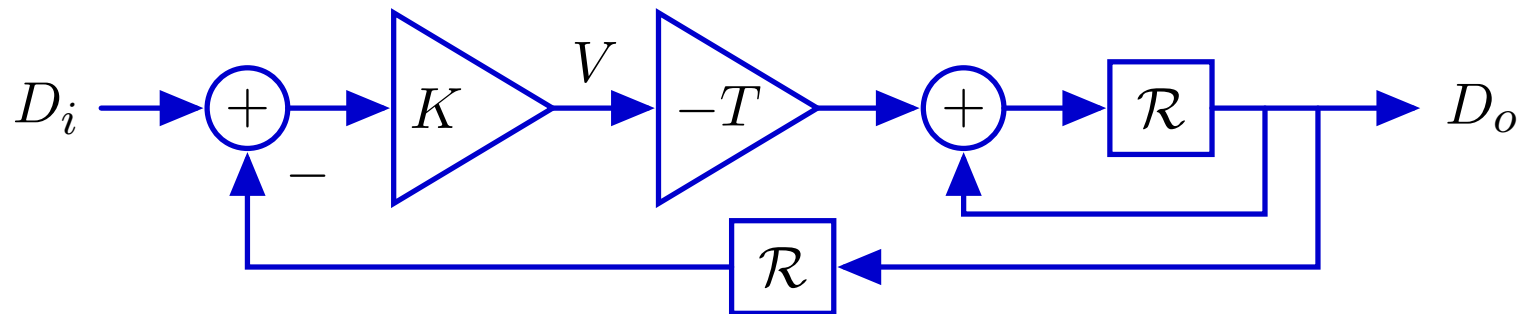

Check Yourself

Find the system function $H = \frac{D_o}{D_i}$.

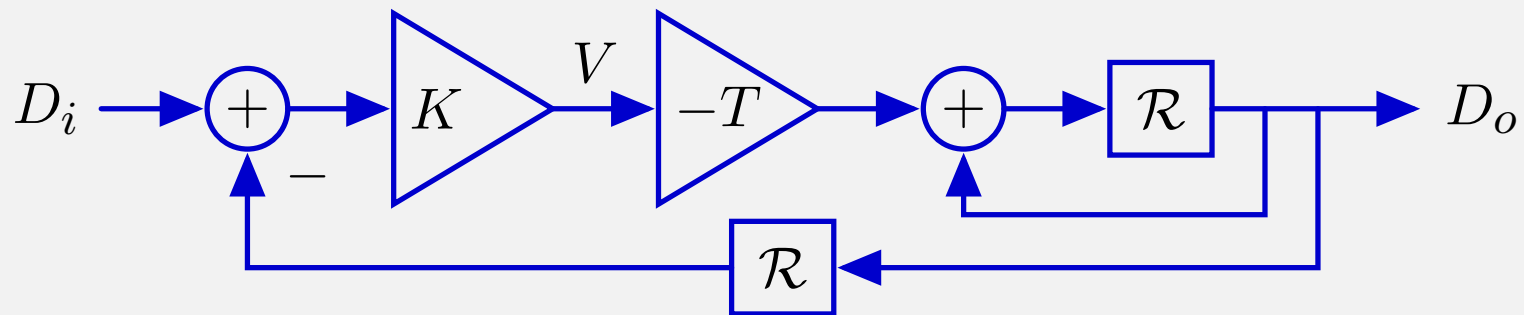

1. $\frac{KTR}{1 - \mathcal{R}}$

2. $\frac{-KTR}{1 + \mathcal{R} - KTR^2}$

3. $\frac{KTR}{1 - \mathcal{R}} - KTR$

4. $\frac{-KTR}{1 - \mathcal{R} - KTR^2}$

5. none of the above

Check Yourself

Find the system function $H = \frac{D_o}{D_i}$.

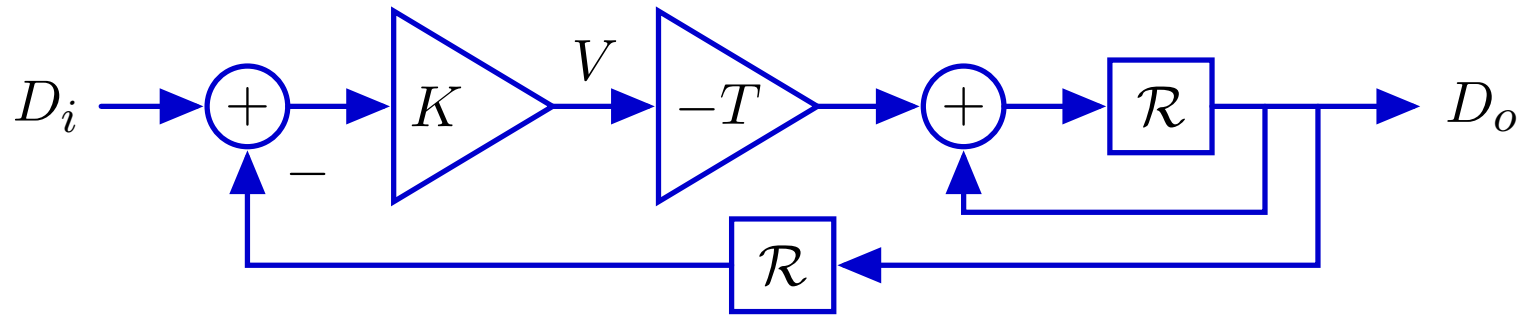

Replace accumulator with equivalent block diagram.

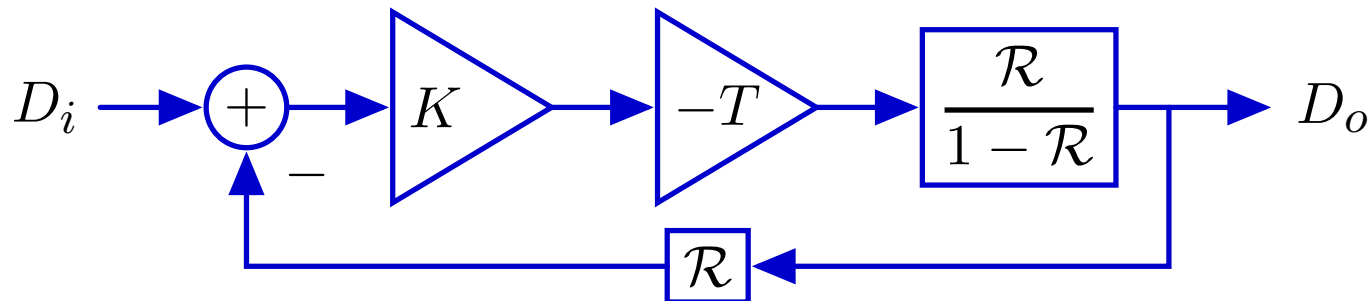

$$\frac{D_o}{D_i} = \frac{\frac{-KTR}{1 - \mathcal{R}}}{1 + \frac{-KTR^2}{1 - \mathcal{R}}} = \frac{-KTR}{1 - \mathcal{R} - KTR^2}$$

Check Yourself

Find the system function $H = \frac{D_o}{D_i}$.

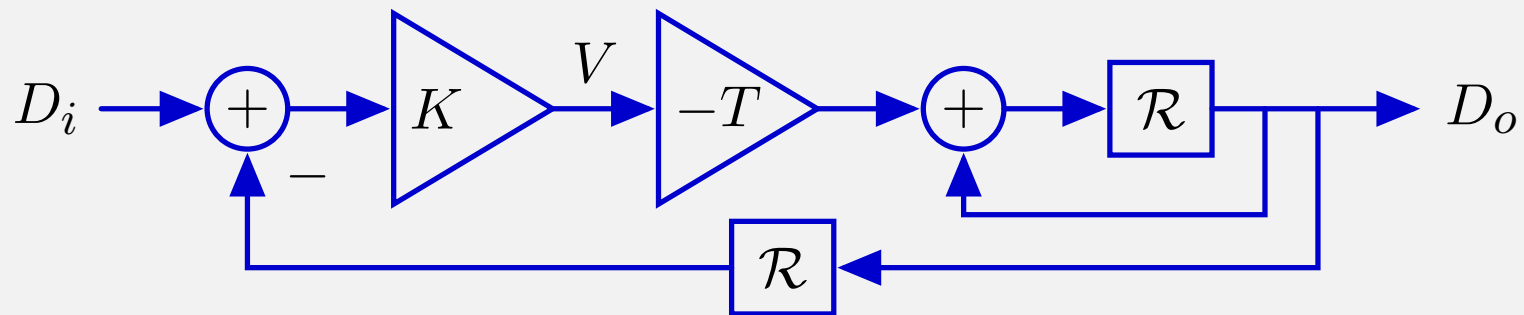

1. $\frac{KTR}{1 - \mathcal{R}}$

2. $\frac{-KTR}{1 + \mathcal{R} - KTR^2}$

3. $\frac{KTR}{1 - \mathcal{R}} - KTR$

4. $\frac{-KTR}{1 - \mathcal{R} - KTR^2}$

5. none of the above

Analyzing wallFinder: Poles

Substitute $\mathcal{R} \rightarrow \frac{1}{z}$ in the system functional to find the poles.

$$\frac{D_o}{D_i} = \frac{-KTR}{1 - \mathcal{R} - KTR^2} = \frac{-KT\frac{1}{z}}{1 - \frac{1}{z} - KT\frac{1}{z^2}} = \frac{-KTz}{z^2 - z - KT}$$

The poles are then the roots of the denominator.

$$z = \frac{1}{2} \pm \sqrt{\left(\frac{1}{2}\right)^2 + KT}$$

Feedback and Control: Poles

If KT is small, the poles are at $z \approx -KT$ and $z \approx 1 + KT$.

$$z = \frac{1}{2} \pm \sqrt{\left(\frac{1}{2}\right)^2 + KT} \approx \frac{1}{2} \pm \sqrt{\left(\frac{1}{2} + KT\right)^2} = 1 + KT, -KT$$

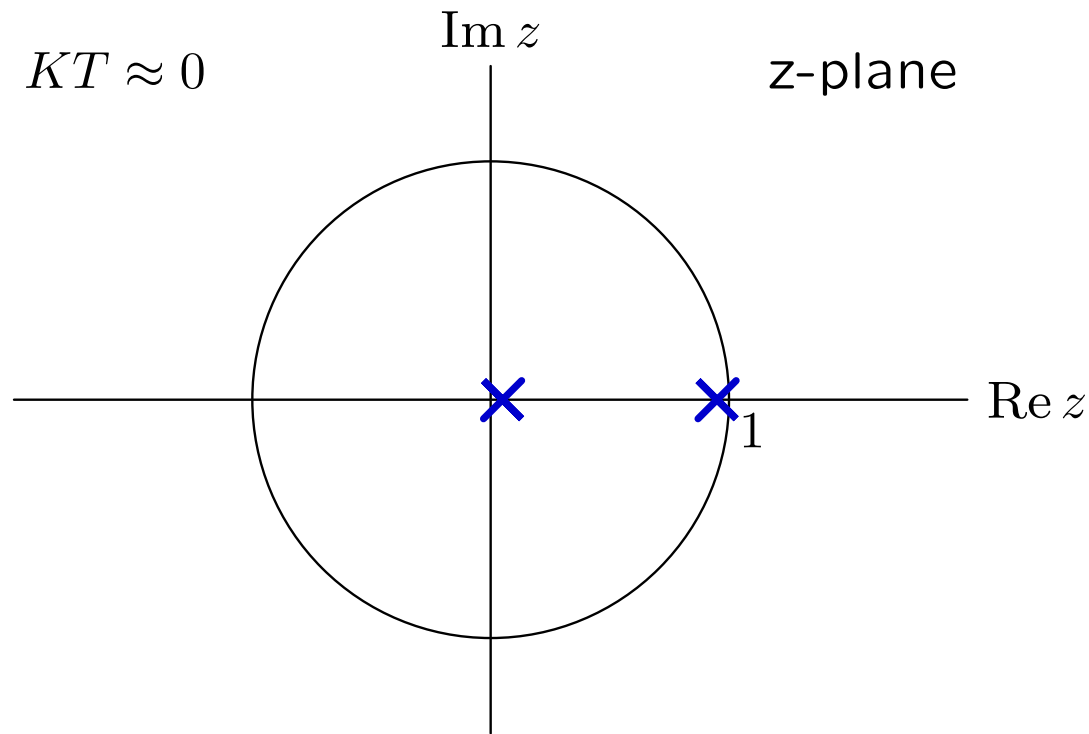

Pole near 0 generates fast response.

Pole near 1 generates slow response.

Slow mode (pole near 1) dominates the response.

Feedback and Control: Poles

As KT becomes more negative, the poles move toward each other and collide at $z = \frac{1}{2}$ when $KT = -\frac{1}{4}$.

$$z = \frac{1}{2} \pm \sqrt{\left(\frac{1}{2}\right)^2 + KT} = \frac{1}{2} \pm \sqrt{\left(\frac{1}{2}\right)^2 - \frac{1}{4}} = \frac{1}{2}, \frac{1}{2}$$

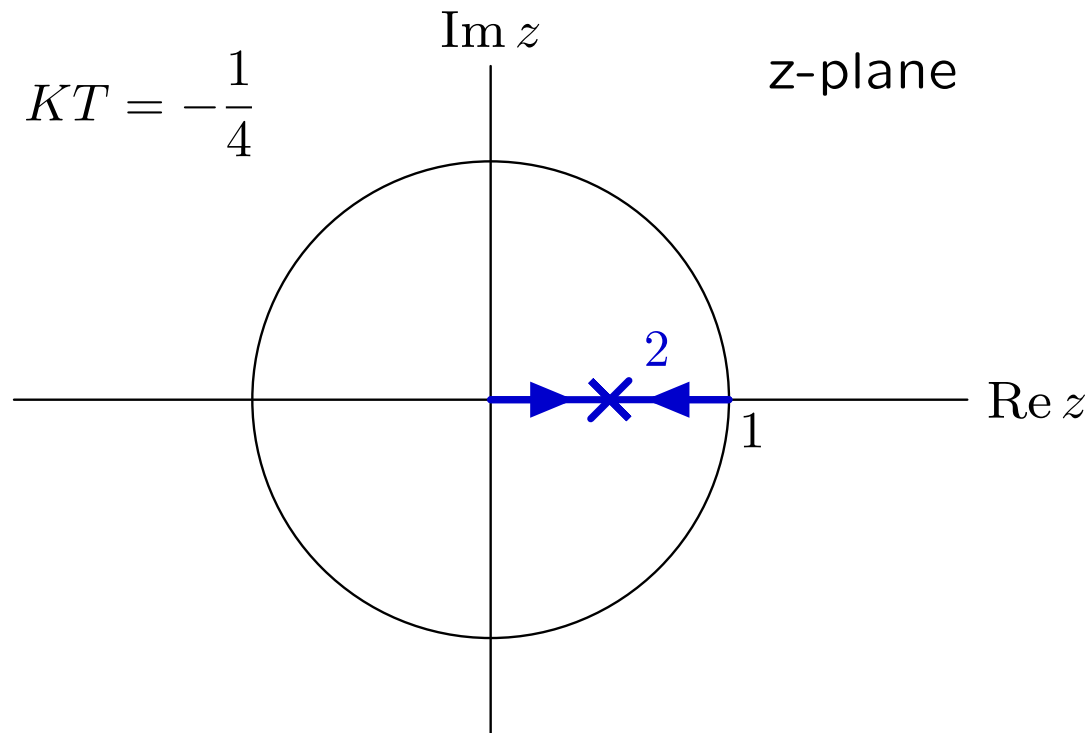

Persistent responses decay. The system is stable.

Feedback and Control: Poles

If $KT < -1/4$, the poles are complex.

$$z = \frac{1}{2} \pm \sqrt{\left(\frac{1}{2}\right)^2 + KT} = \frac{1}{2} \pm j\sqrt{-KT - \left(\frac{1}{2}\right)^2}$$

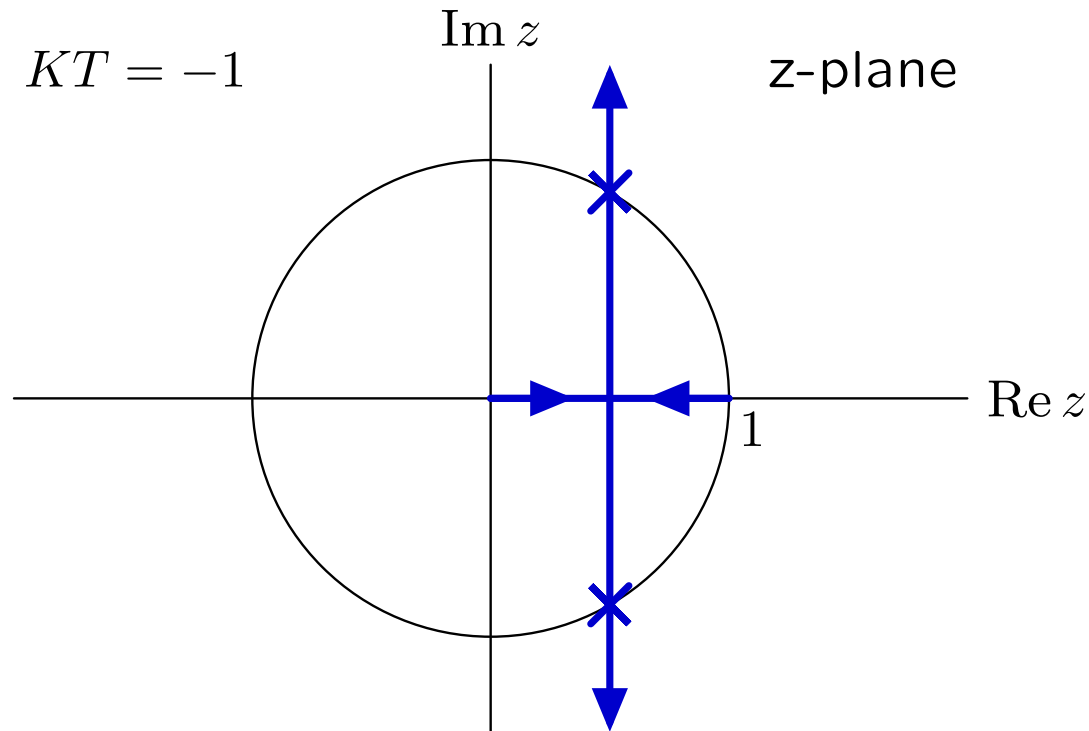

Complex poles \rightarrow oscillations.

Same oscillation we saw earlier!

Adding delay tends to destabilize control systems.

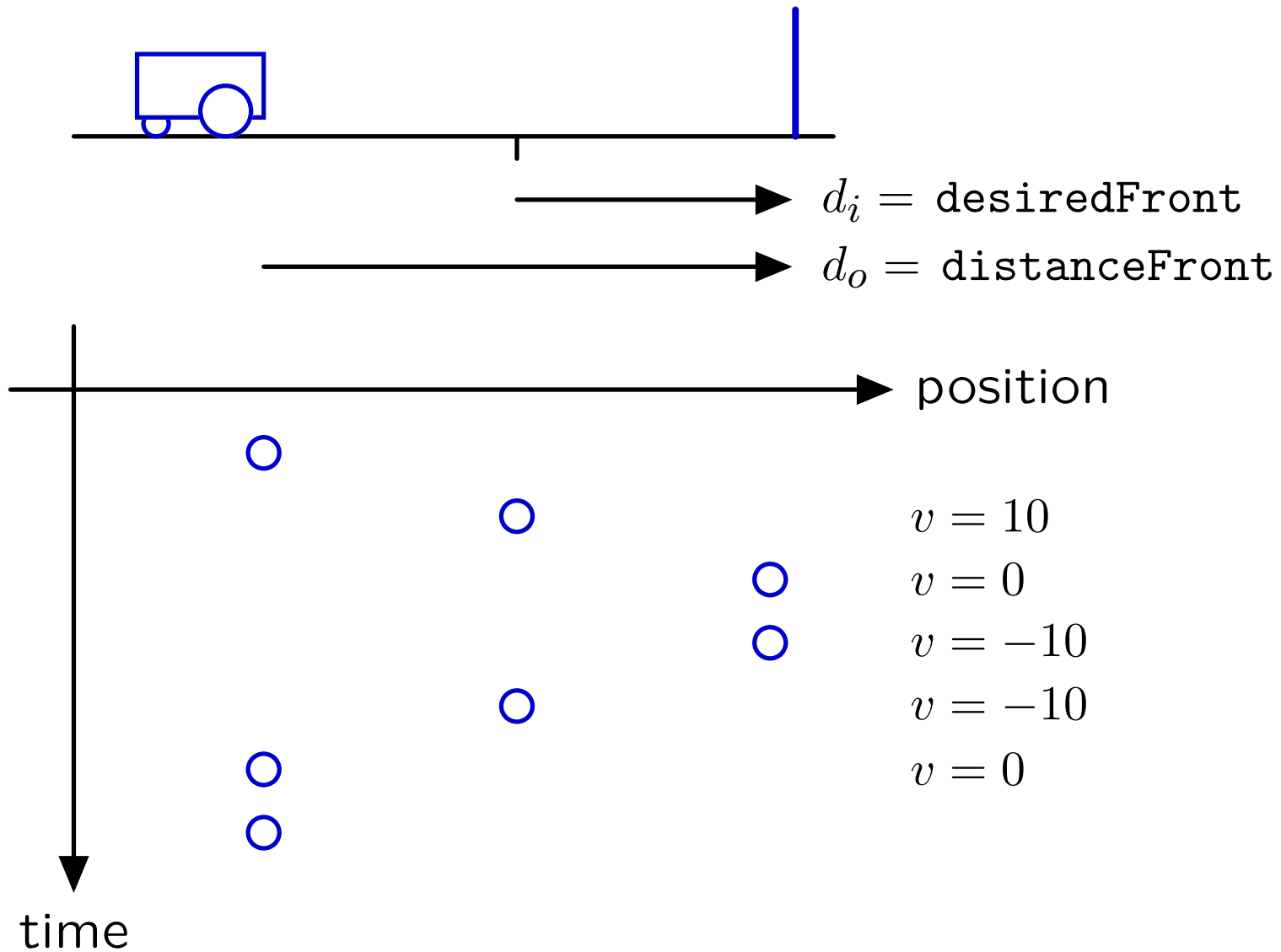

Check Yourself

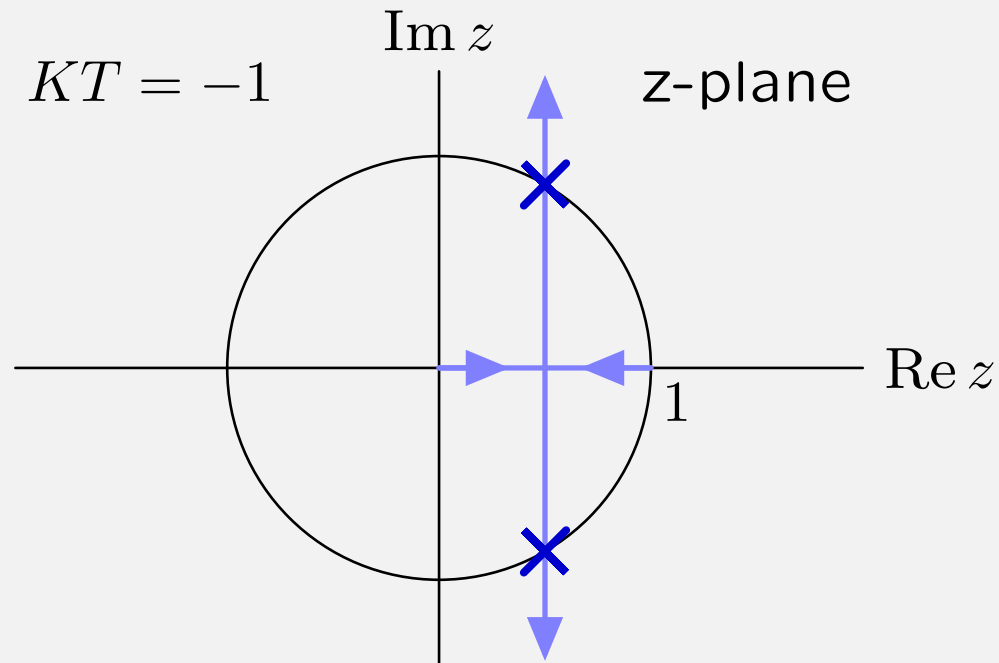

What is the period of the oscillation?

1. 1

2. 2

3. 3

4. 4

5. 6

0. none of above

Check Yourself

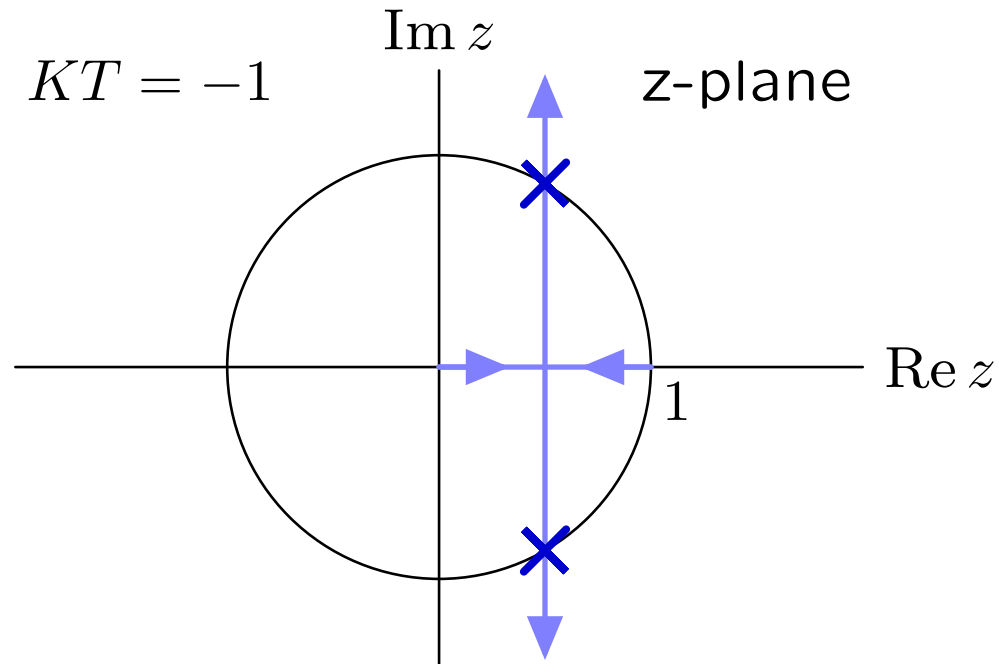

$$p_0 = \frac{1}{2} \pm j \frac{\sqrt{3}}{2} = e^{\pm j\pi/3}$$

$$p_0^n = e^{\pm j\pi n/3}$$

$$\underbrace{e^{\pm j0\pi/3}}_1, e^{\pm j\pi/3}, e^{\pm j2\pi/3}, e^{\pm j3\pi/3}, e^{\pm j4\pi/3}, e^{\pm j5\pi/3}, \underbrace{e^{\pm j6\pi/3}}_{e^{\pm j2\pi}=1}$$

Check Yourself

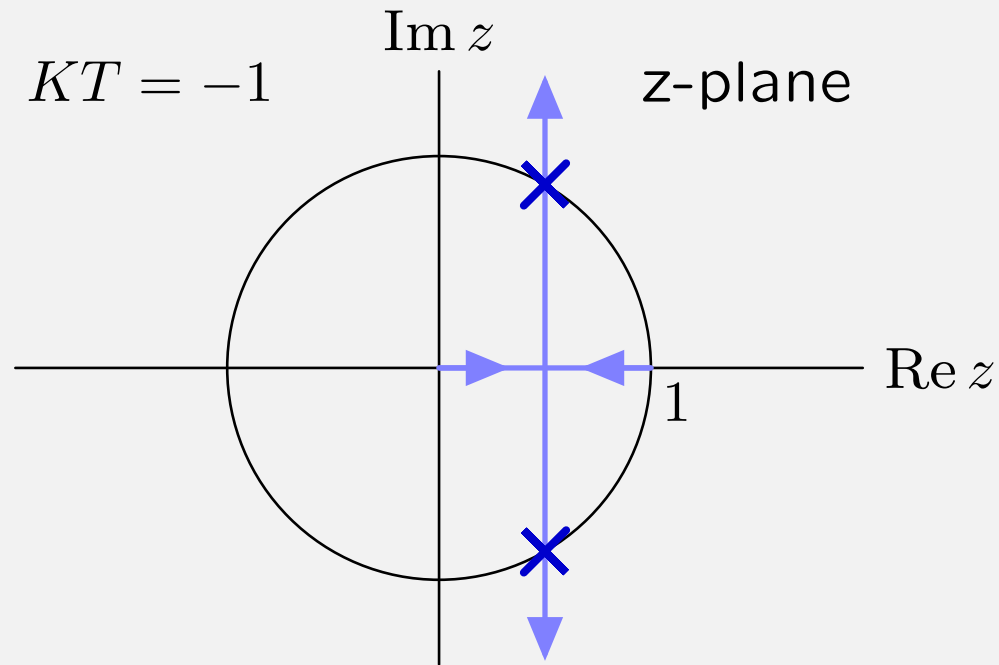

What is the period of the oscillation?

1. 1

2. 2

3. 3

4. 4

5. 6

0. none of above

Feedback and Control: Poles

The closed loop poles depend on the gain.

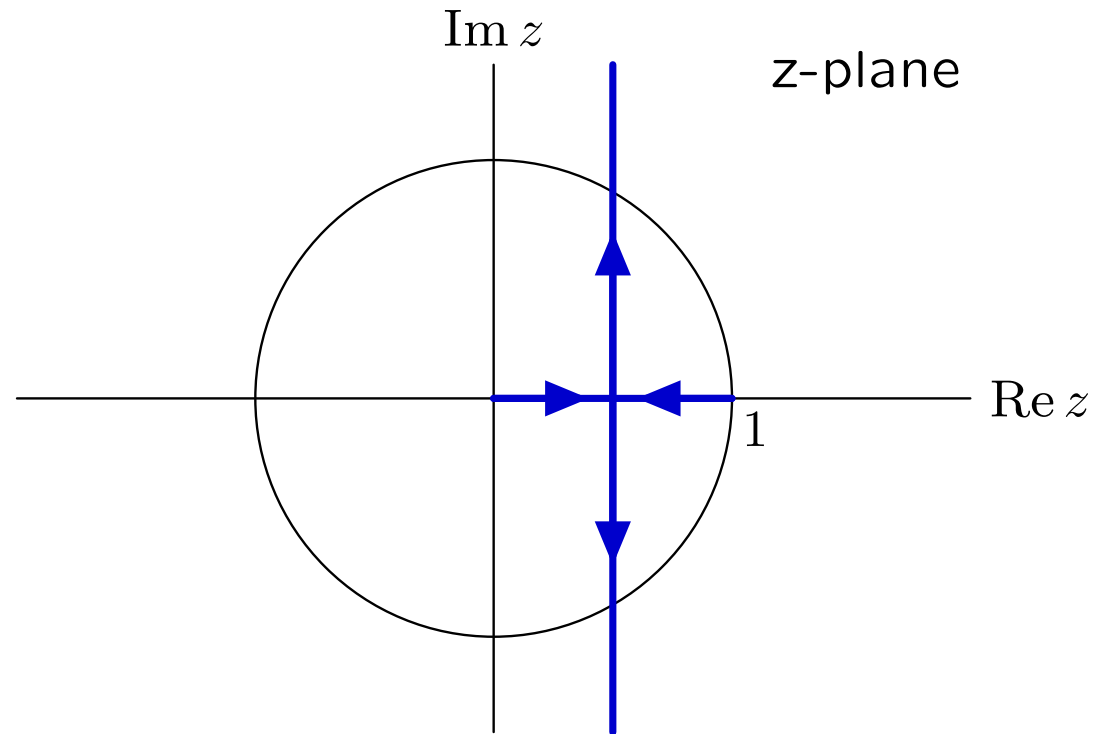

If $KT : 0 \rightarrow -\infty$: then $z_1, z_2 : 0, 1 \rightarrow \frac{1}{2}, \frac{1}{2} \rightarrow \frac{1}{2} \pm j\infty$

Check Yourself

Find KT for fastest response.

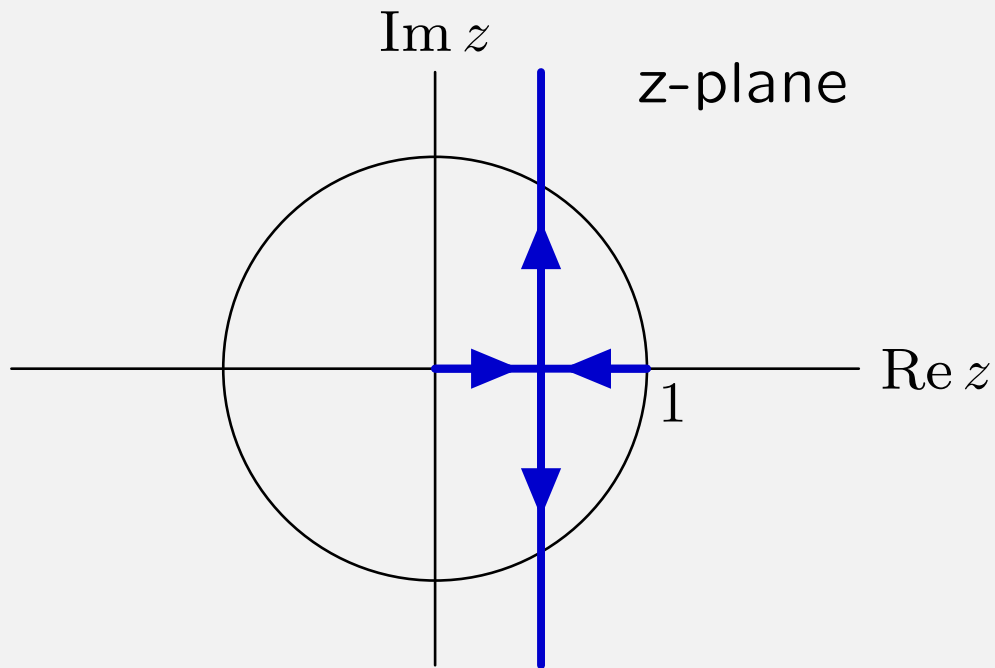

closed-loop poles

$$\frac{1}{2} \pm \sqrt{\left(\frac{1}{2}\right)^2 + KT}$$

- | | | |
|-------|-------------------|-------------------|
| 1. 0 | 2. $-\frac{1}{4}$ | 3. $-\frac{1}{2}$ |
| 4. -1 | 5. $-\infty$ | 0. none of above |

Check Yourself

$$z = \frac{1}{2} \pm \sqrt{\left(\frac{1}{2}\right)^2 + KT}$$

The dominant pole always has a magnitude that is $\geq \frac{1}{2}$.

It is smallest when there is a double pole at $z = \frac{1}{2}$.

Therefore, $KT = -\frac{1}{4}$.

Check Yourself

Find KT for fastest response.

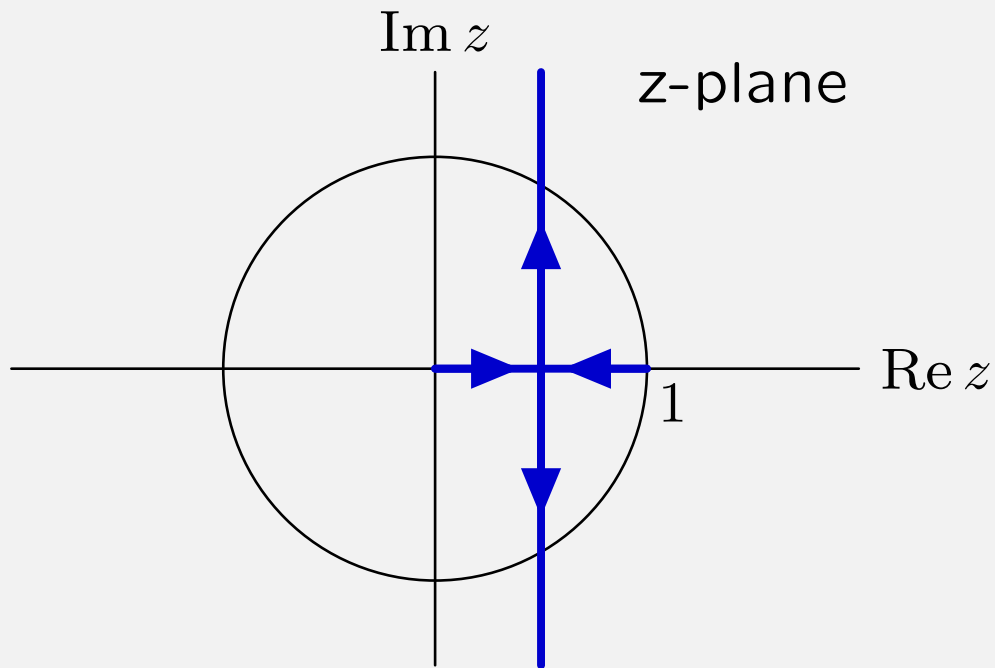

closed-loop poles

$$\frac{1}{2} \pm \sqrt{\left(\frac{1}{2}\right)^2 + KT}$$

- | | | |
|-------|-------------------|-------------------|
| 1. 0 | 2. $-\frac{1}{4}$ | 3. $-\frac{1}{2}$ |
| 4. -1 | 5. $-\infty$ | 0. none of above |

Destabilizing Effect of Delay

Adding delay in the feedback loop makes it more difficult to stabilize.

Ideal sensor: $d_s[n] = d_o[n]$

More realistic sensor (with delay): $d_s[n] = d_o[n - 1]$

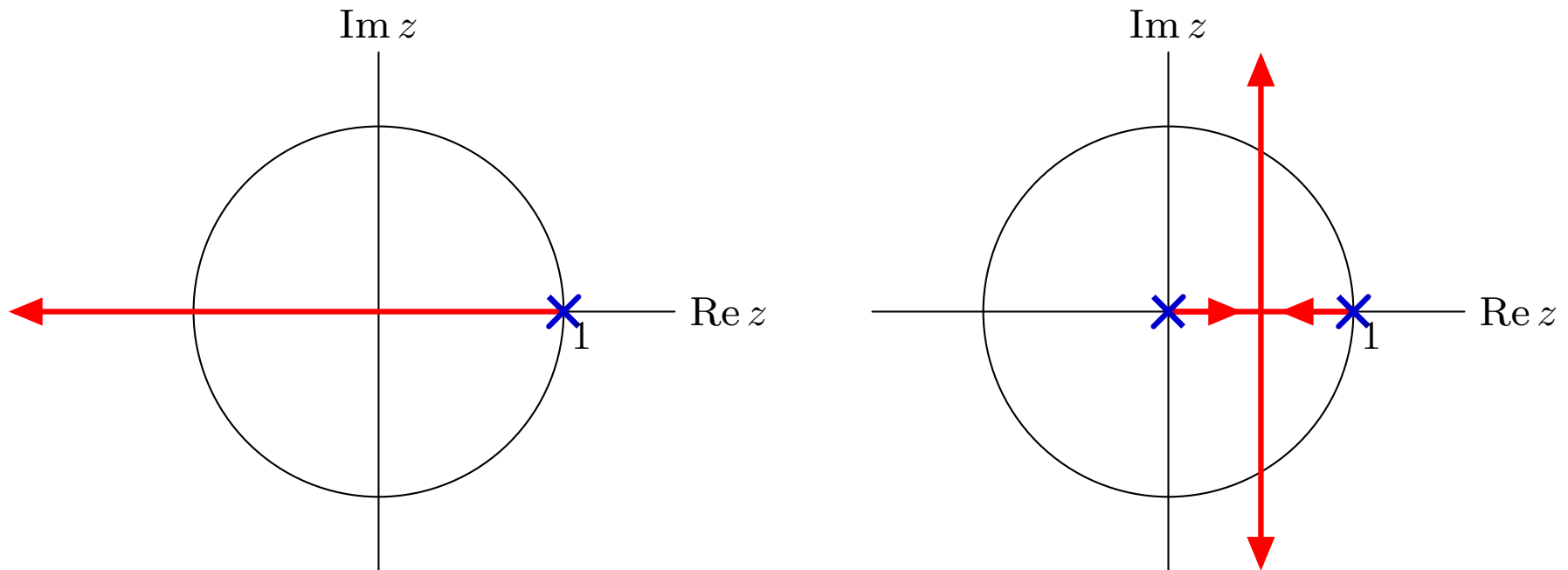

Fastest response without delay: single pole at $z = 0$.

Fastest response with delay: double pole at $z = \frac{1}{2}$. **much slower!**

Destabilizing Effect of Delay

Adding more delay in the feedback loop is even worse.

More realistic sensor (with delay): $d_s[n] = d_o[n - 1]$

Even more delay: $d_s[n] = d_o[n - 2]$

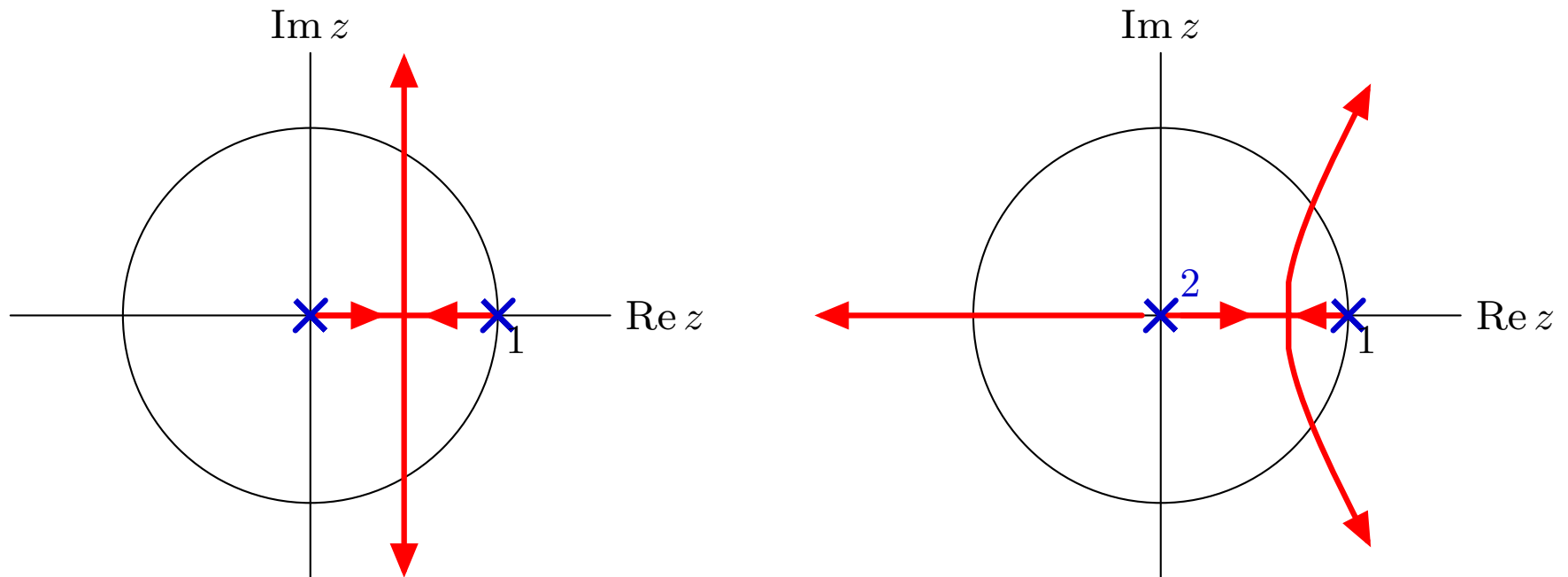

Fastest response with delay: double pole at $z = \frac{1}{2}$.

Fastest response with more delay: double pole at $z = 0.682$.

→ **even slower**

Feedback and Control: Summary

Feedback is an elegant way to design a control system.

Stability of a feedback system is determined by its dominant pole.

Delays tend to decrease the stability of a feedback system.

MIT OpenCourseWare
<http://ocw.mit.edu>

6.003 Signals and Systems
Spring 2010

For information about citing these materials or our Terms of Use, visit: <http://ocw.mit.edu/terms>.